

UNITED NATIONS INDUSTRIAL DEVELOPMENT ORGANIZATION

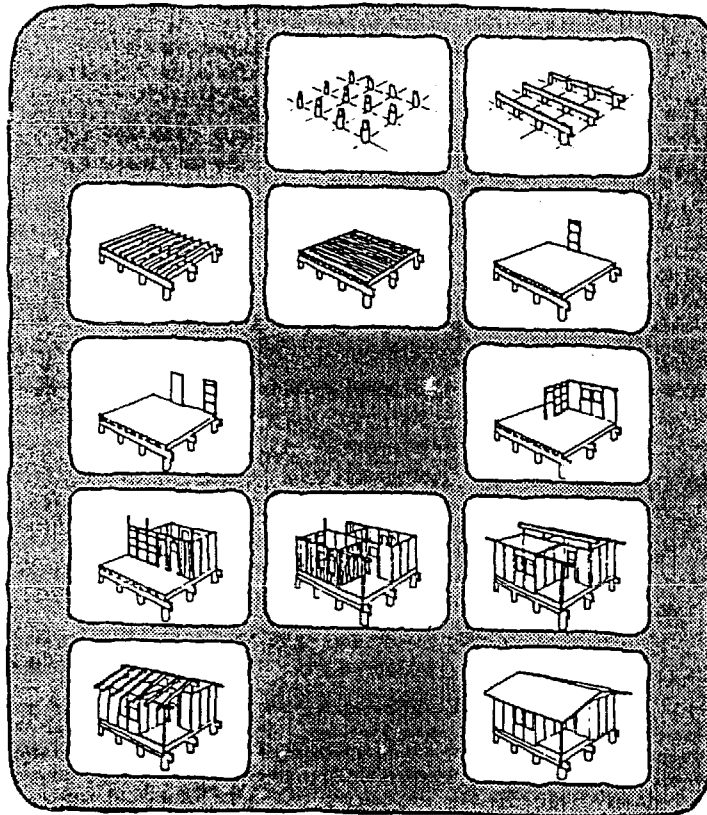

POPULAR
MANUAL FOR
WOODEN
HOUSE
CONSTRUCTION

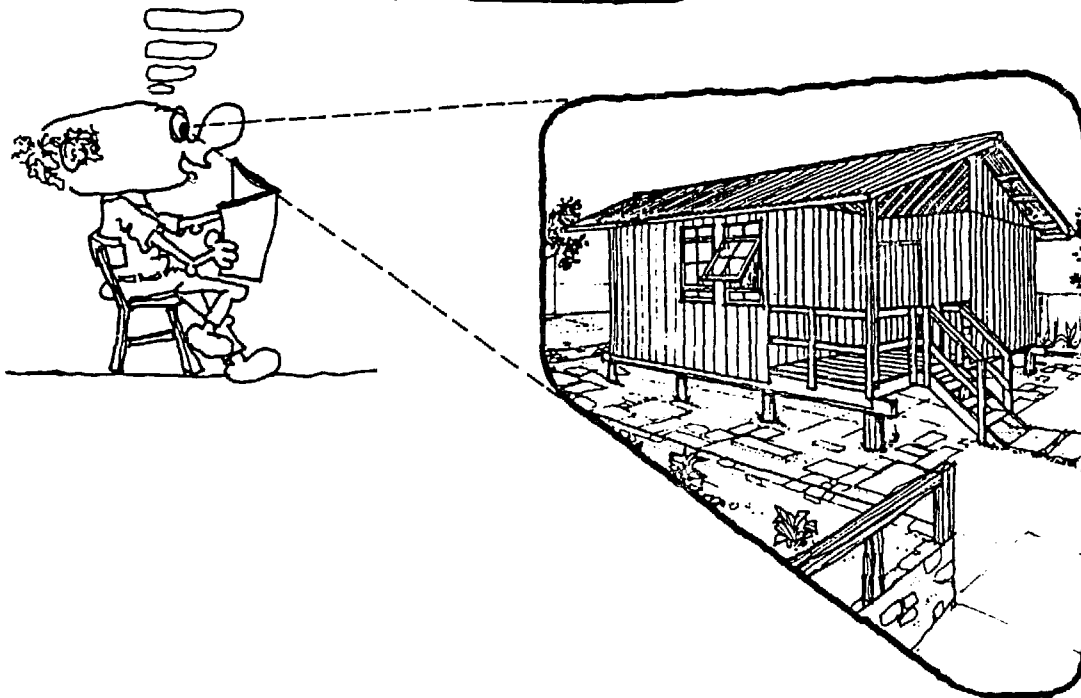

UNITED NATIONS

UNITED NATIONS INDUSTRIAL DEVELOPMENT ORGANIZATION
Vienna

POPULAR MANUAL FOR WOODEN HOUSE CONSTRUCTION



UNITED NATIONS
New York, 1985

Abstract

The Popular Manual for Wooden House Construction presents a construction system aimed at helping low-income families solve their housing needs. The system can be used in regions that have ample timber. The Manual is written in simple language and has many sketches to facilitate its use.

The first part of the Manual discusses the:

Design of the house

Quantities of materials needed

Pre-fabrication and pre-cutting of components

Construction of the house

Finishing

Adaptations and modifications

The major part of the Manual is devoted to the actual construction of the house:

Layout and putting up piles

Laying the floor frame and floorboards

Erecting the panels

Erecting the roof frame and putting on the roof

Windows and doors

Although the construction system was conceived and implemented in the Amazon region of Brazil, information on wood species found in Africa and Asia is also included, as are data on the required physical and mechanical characteristics of the wood used in the various parts of the house. Thus, the Manual can be of use in many regions of Africa, Asia and Latin America.

Preface

The Popular Manual for Wooden House Construction was originally prepared by the Instituto de Pesquisas Tecnológicas (IPT), São Paulo, Brazil, for a self-help community building project at Coroados, Manaus, under a contract with the Housing Society for the Amazon State (SHAM). (Photographs 1 to 4 show the project at various stages, including a view of completed houses.)

An experimental group of 40 houses was built during the period November 1981-March 1982. The average cost was \$US 49.70 to \$US 59.50 per square metre (as of March 1982), depending on the area, which averaged 40 square metres, and the type of foundation used (stone or ceramic blocks and a cement or wooden floor). All houses were equipped with bathrooms built with concrete blocks. The cost included the materials delivered at the construction site and the labour for manufacture and assembly and for masonry, electrical and pipe work. It did not include materials and labour for painting; electrical, water and sewerage installations; nails and tools; and land acquisition and infrastructure.

The purpose of this Manual is to provide direct and simple assistance to people and communities that want to build their own houses either individually or on a co-operative basis. Complicated design calculations have been omitted and instructions are straightforward and easy to follow. The format used enables interested parties to reproduce the Manual in their own language by translating the captions and inserting them in the appropriate places. The United Nations Industrial Development Organization (UNIDO) is willing to make available good originals for this purpose to Governments, national bodies or groups. The only requirements are that full acknowledgement and credit must be given to UNIDO and to IPT for the original work and that UNIDO must receive two complimentary copies of any such reproduction.



Photo 1. Partial view of the IPT/SHAM houses under construction in Coroados, Manaus, Brazil

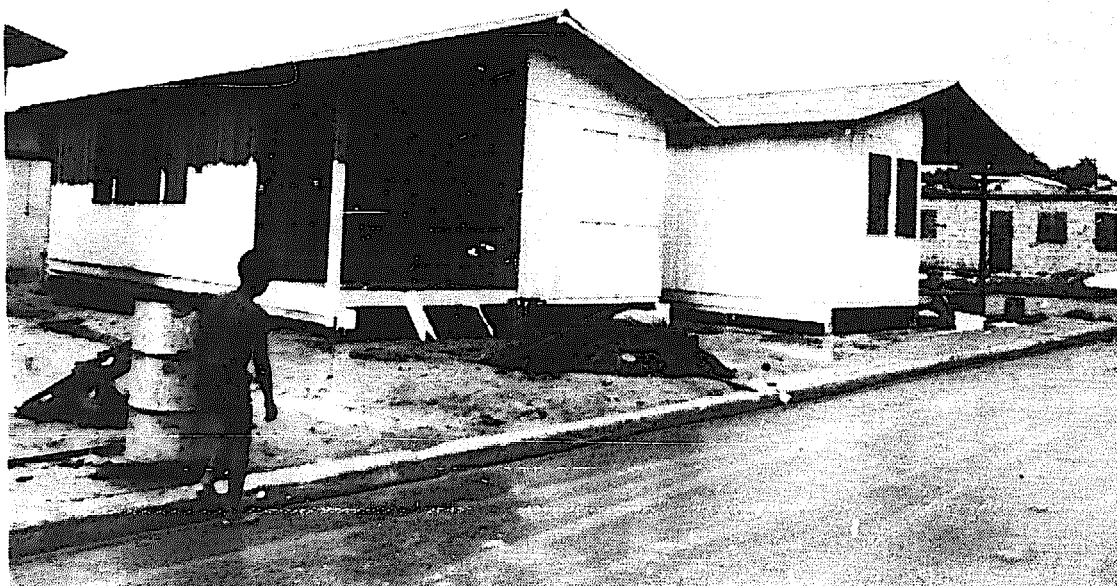

Photo 2. The houses being painted with PVA-based paint



Photo 3. View of houses nearing completion. In the foreground, house with ceramic block foundation and cement floor

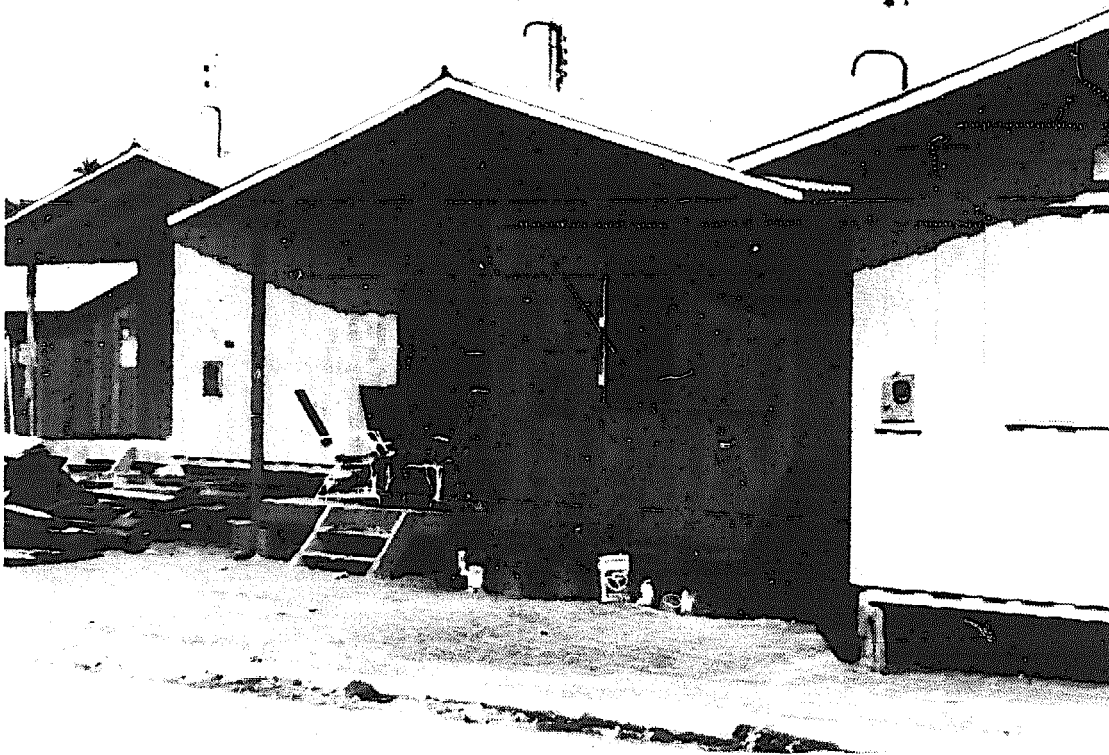
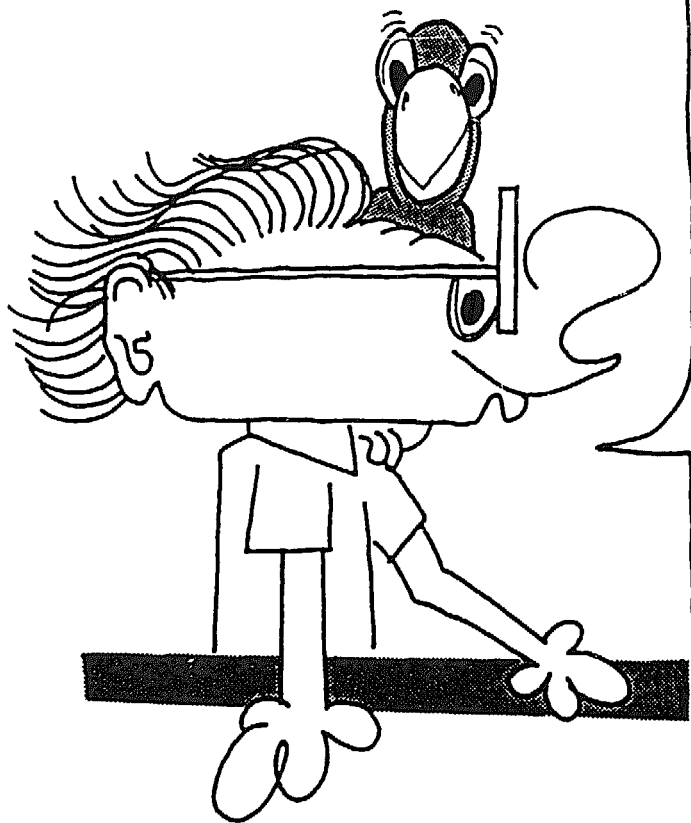

Photo 4. View of finished houses, already occupied



AH, I ALMOST FORGOT TO INTRODUCE YOU TO SOMEONE HERE ON MY SHOULDER.

HER NAME IS **POLLY** AND NOW THE TWO OF US WILL SHOW YOU WHAT THE HOUSE IS LIKE. YOU ARE GOING TO LEARN ABOUT :

- THE HOUSE 3
- ITS COMPONENTS 4
- THE TYPES AVAILABLE 8
- HOW TO LOCATE IT ON YOUR PLOT 25
- WHAT TO DO WHEN YOUR PLOT IS FLAT, SWAMPY OR SLOPED . . 26
- HOW TO BUILD TOILET AND BATH FACILITIES 28
- WHAT CHANGES YOU CAN MAKE 29
- AND , FINALLY,
- THE BEST WAY TO BUILD YOUR HOUSE . . 32

HI, FRIENDS!

MY NAME IS **TONY**

I'M GOING TO TELL YOU HOW TO BUILD A HOUSE
QUICKLY AND CHEAPLY.

I'M GOING TO SHOW YOU :

- **WHAT THE HOUSE IS LIKE** 2
- **HOW TO MAKE ITS PARTS** 33
- **HOW TO BUILD IT** 46

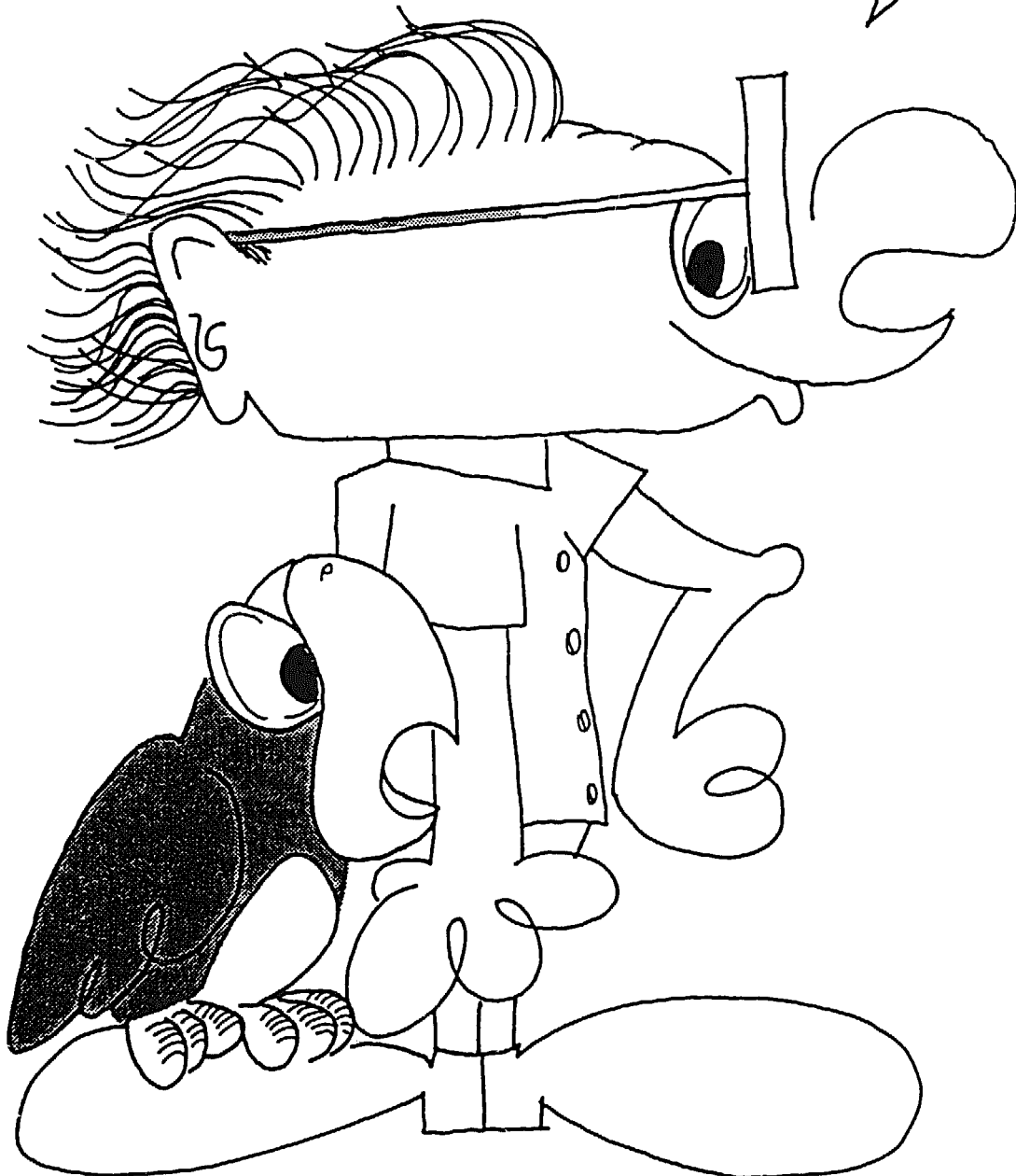

YOU CAN MAKE YOUR HOUSE BIGGER
 OR SMALLER THAN OUR MODEL, AS
 WELL AS IDENTICAL TO IT.
 IF YOU ARE NOT ABLE TO BUILD A
 BIG HOUSE AT THE MOMENT, START
 WITH A SMALLER ONE AND MAKE
 IT BIGGER LATER.

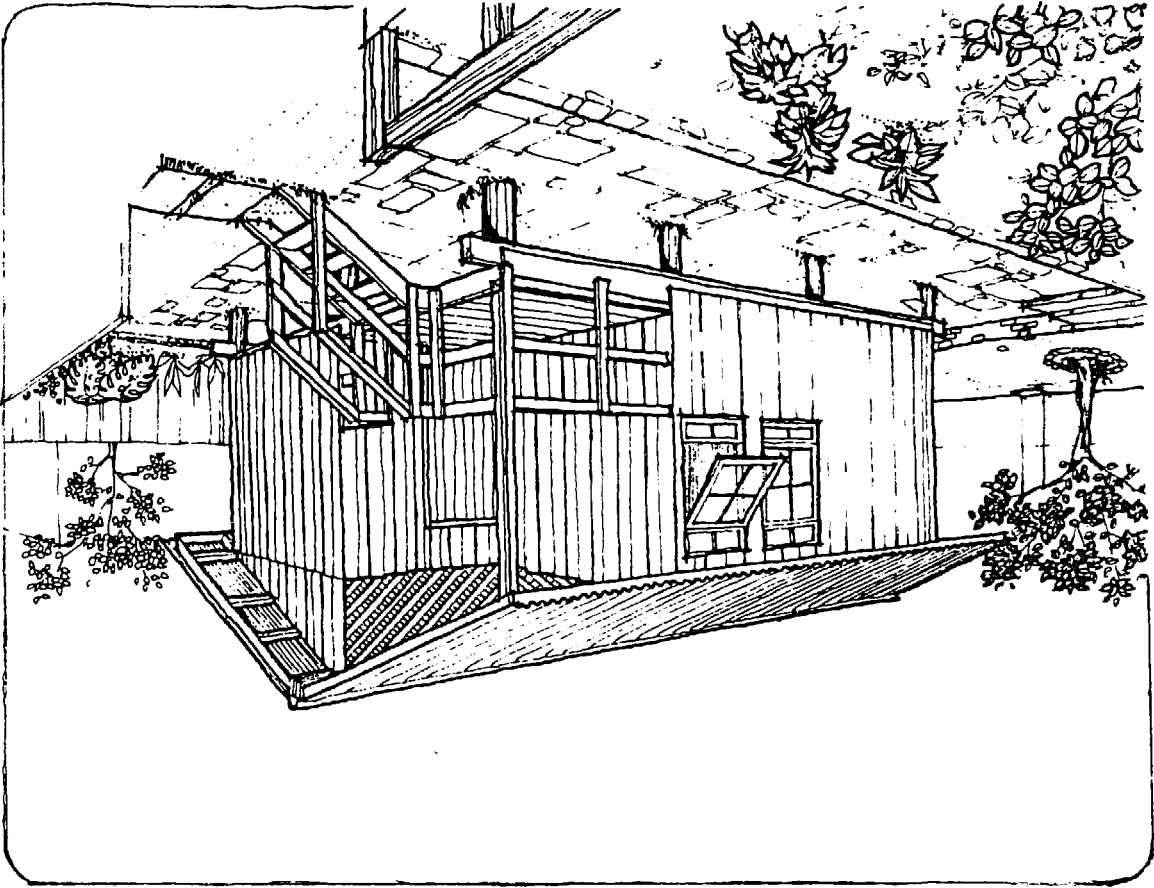

THE HOUSE IS MADE OF WOOD OF SUITABLE
 SPECIES (AND DEPENDING ON THE USE
 EITHER NATURALLY DURABLE OR PRESERVATIVE
 TREATED - SEE TABLES AT END OF MANUAL).
 CONSTRUCTION IS SIMPLE AND YOU CAN
 EASILY DO IT YOURSELF.

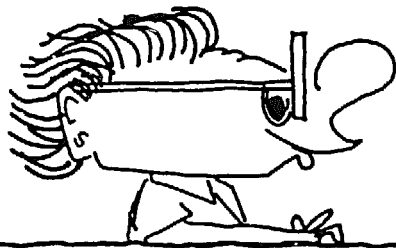

LET'S EXAMINE THE PARTS OF THE HOUSE ...

THIS HOUSE IS SIMILAR TO ONES YOU OFTEN SEE. THE DIFFERENCE IS THAT MANY PARTS OF THIS HOUSE CAN BE MADE BEFORE YOU START CONSTRUCTION.

START THE CONSTRUCTION BY PUTTING PILES FIRMLY INTO THE GROUND

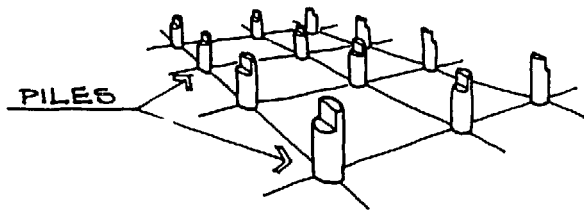

BEAMS ARE PLACED ACROSS THE PILES AND ...

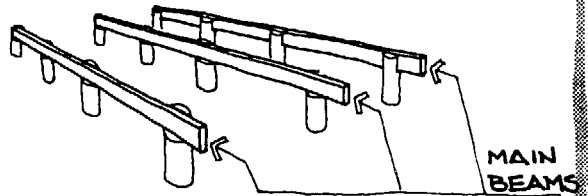

... JOISTS WITH STIFFENING CROSS PIECES ARE LAID ON THESE.

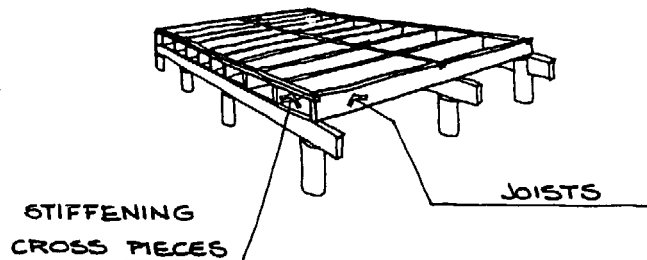

THEN THE FLOORBOARDS ARE NAILED TO THE JOISTS.

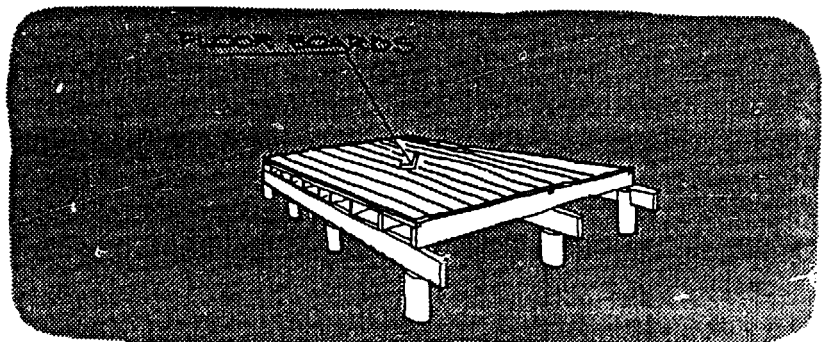

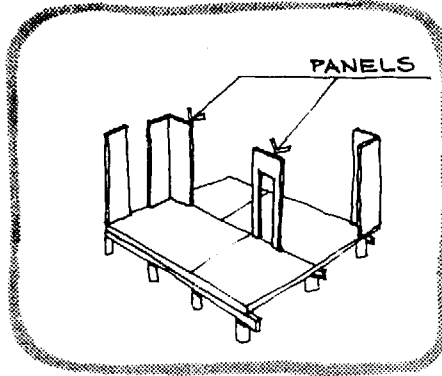

THE WALLS ARE MADE OUT OF PREASSEMBLED PANELS. THAT IS, THEY ARE MADE BEFORE CONSTRUCTION BEGINS.

ALL THE PARTS SHOWN FROM NOW ON ARE TO BE ASSEMBLED BEFORE DELIVERY TO THE SITE.

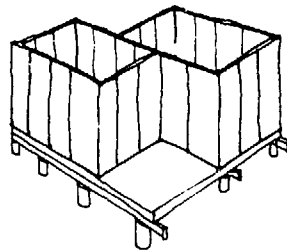

BY USING PANELS THE ERECTION OF WALLS IS EASY. YOU JUST LOCATE EACH PANEL IN ITS RIGHT PLACE AND NAIL IT TO THE FRAME.

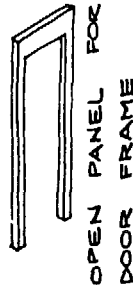
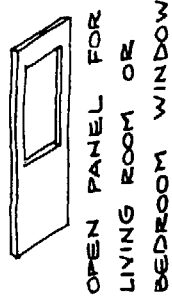
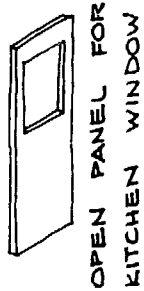
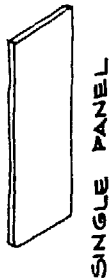

THERE ARE FOUR TYPES OF PANELS:

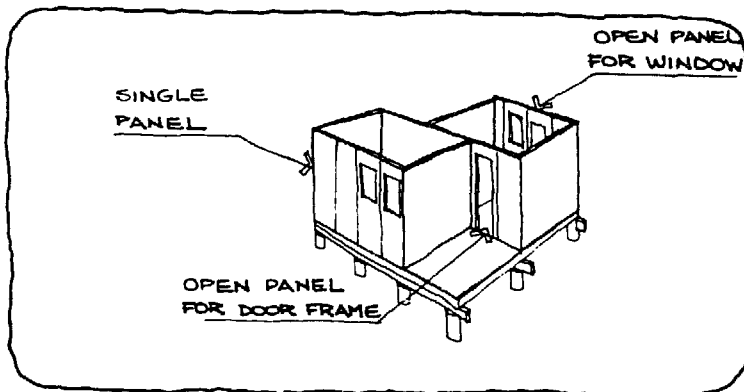

THE DIFFERENT PANELS ARE ARRANGED SO THAT THE WALLS, DOORS AND WINDOWS ARE WHERE YOU WANT THEM.

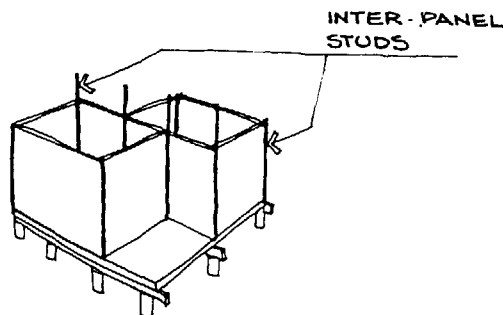

THE PANELS ARE FIXED FIRMLY TOGETHER USING VERTICAL CONNECTING PIECES (ALSO CALLED INTER-PANEL STUDS)

NEXT, THE EXTERNAL POSTS AND BEAMS MUST BE INSTALLED.

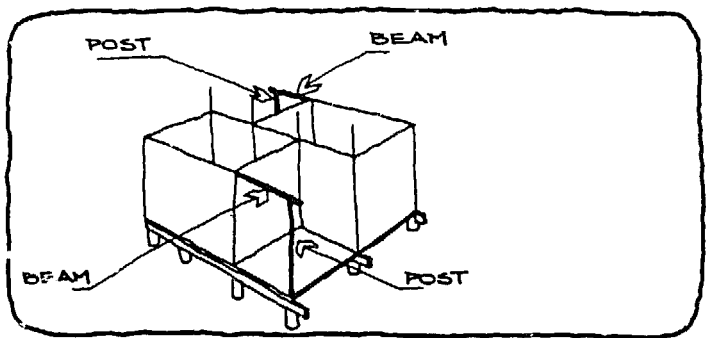

AND FINALLY "TOP PLATES" ARE PUT IN PLACE.

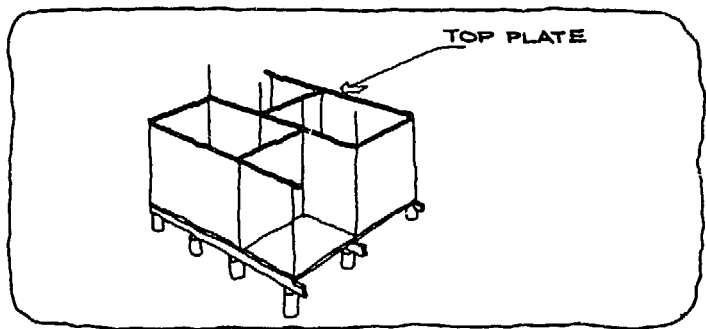

YOU BEGIN THE ROOF ASSEMBLY BY SETTING UP THE RIDGE BEAM...

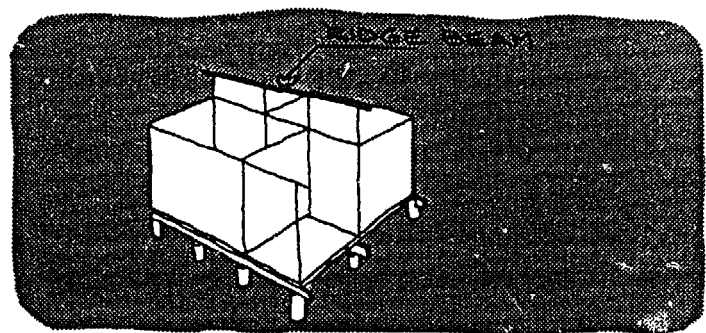

... THEN THE RAFTERS AND PURLINS

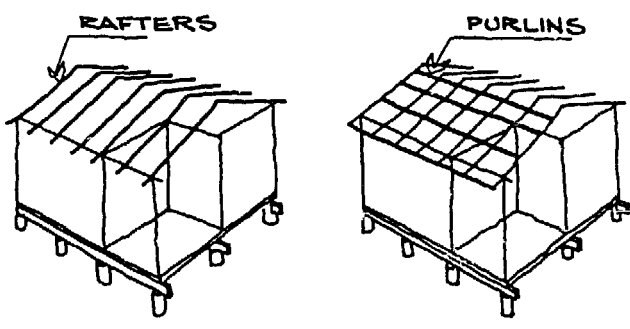

TO FINISH THE ROOF, A ROOFING MATERIAL IS LAID AND A FACING BOARD IS FIXED AT THE ENDS.

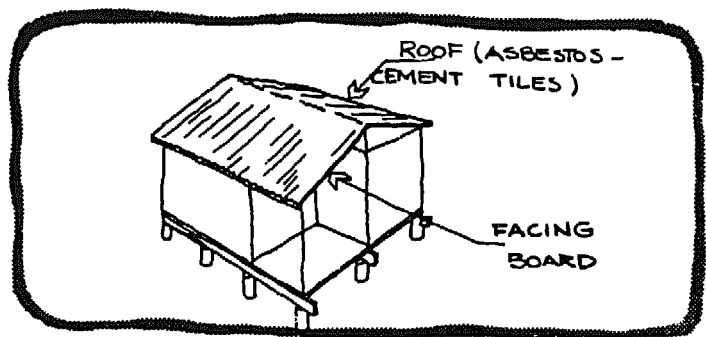

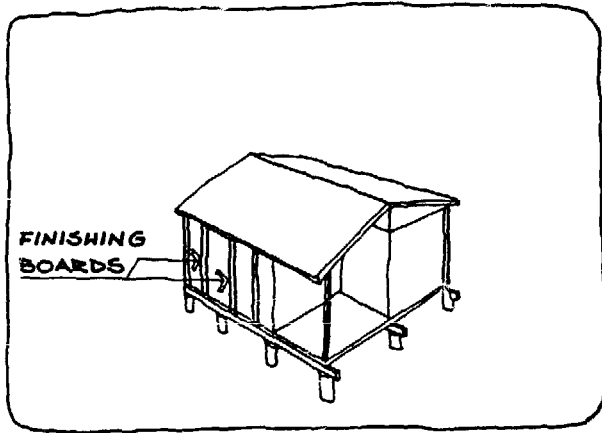

TO FINISH THE WALLS YOU SEAL THE GAPS BETWEEN THE PANELS AND AT THE CORNERS WITH BOARDS.

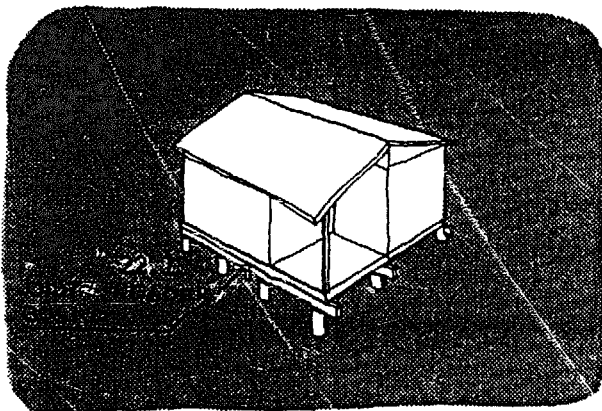

TO FINISH THE FLOORING YOU NAIL BOARDS TO THE ENDS OF THE JOISTS ON THE OUTSIDE OF THE HOUSE.

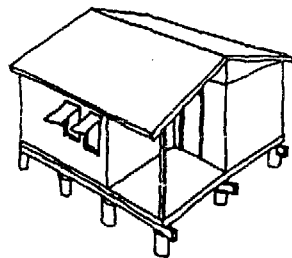

HANG THE DOORS, WINDOWS AND ...

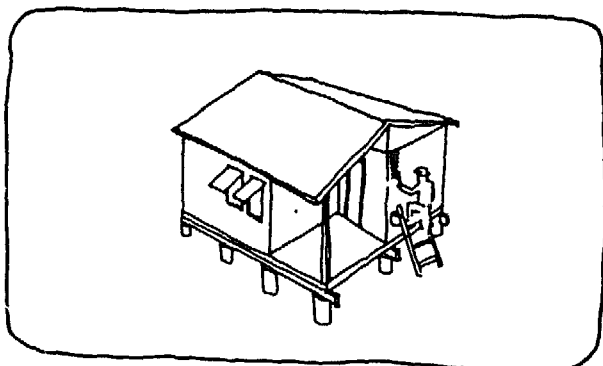

... NOW YOU CAN PAINT YOUR HOUSE FOR GREATER DURABILITY.

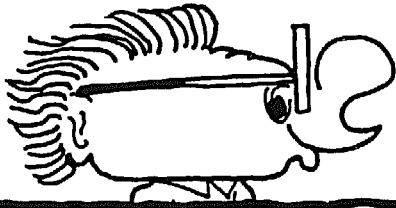

HERE ARE THE HOUSE TYPES
YOU CAN BUILD.

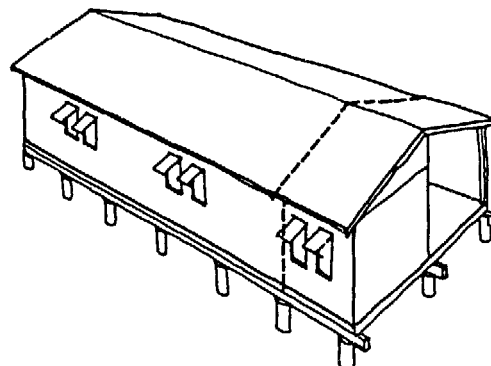
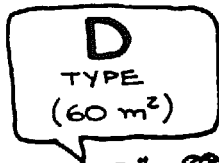
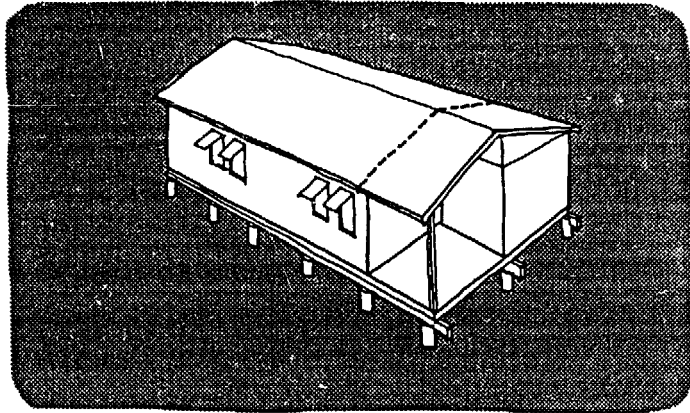
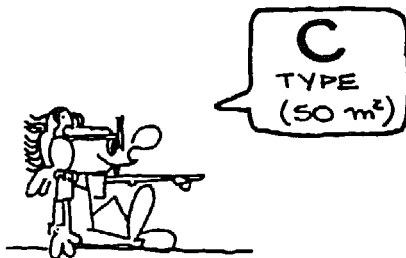
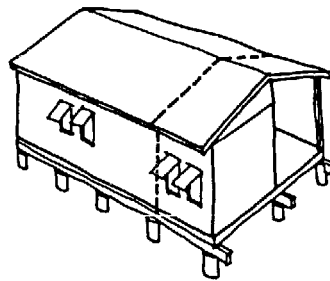
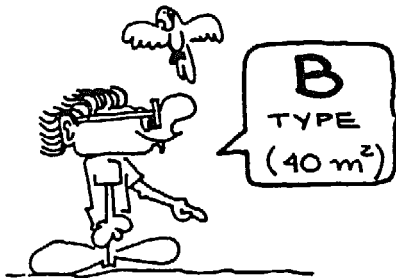
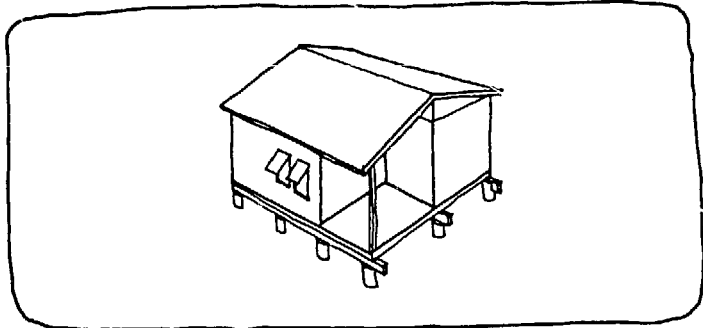
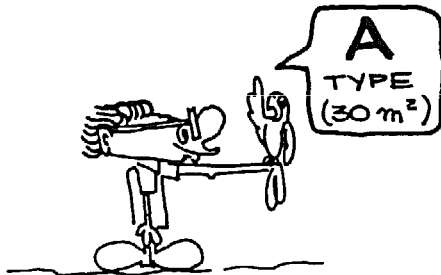





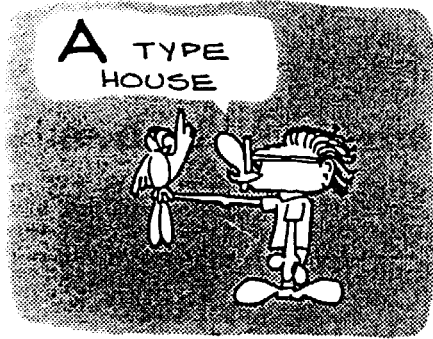



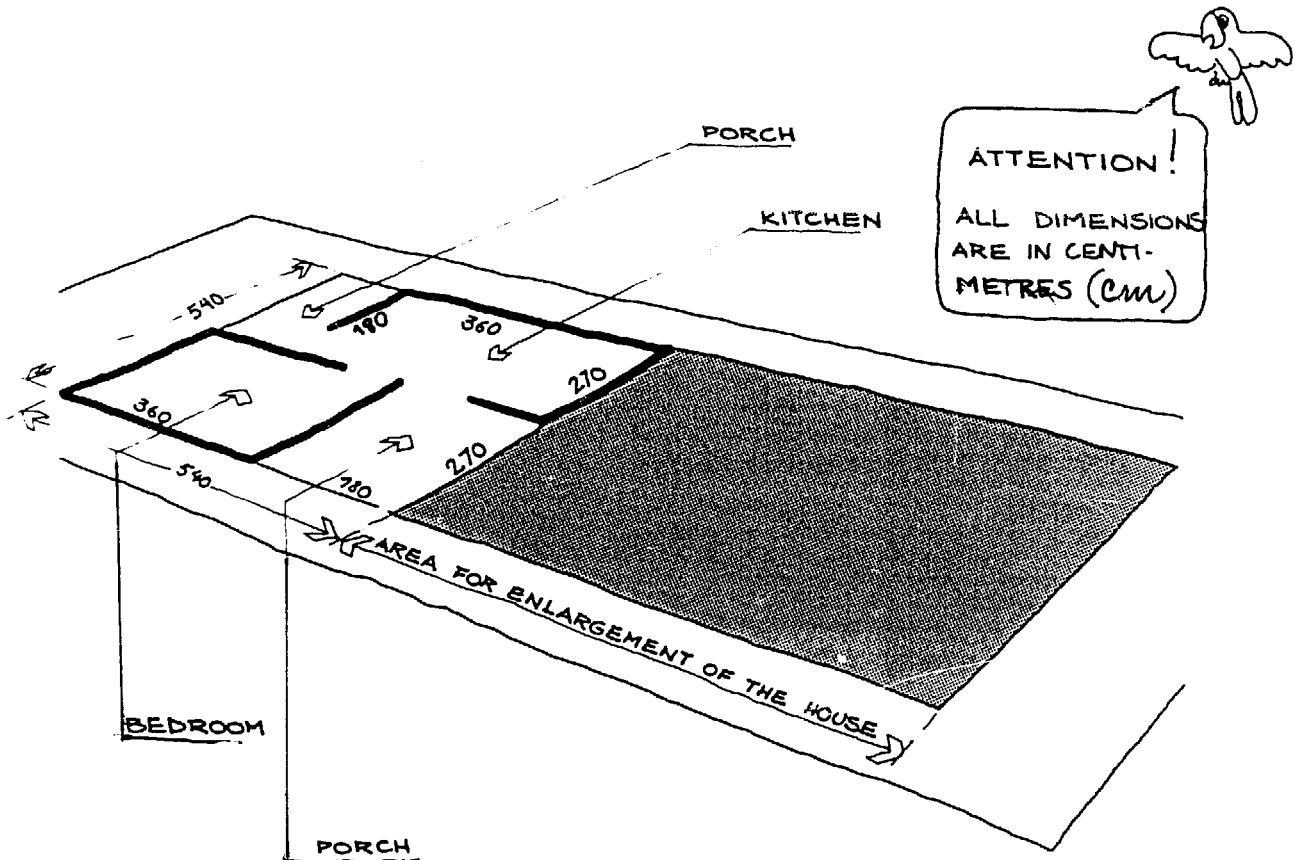



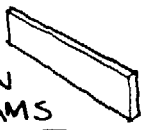

TO CHOOSE BETWEEN HOUSE TYPES, YOU MUST DECIDE ON THE NUMBER OF ROOMS YOU NEED. YOU MUST ALSO CALCULATE THE AMOUNT OF MATERIAL YOU CAN AFFORD TO BUY. NOW YOU ARE GOING TO SEE IN MORE DETAIL THE FOUR TYPES OF HOUSES THAT YOU CAN MAKE.











HERE ARE THE DIMENSIONS AND QUANTITIES OF THE DIFFERENT PIECES NECESSARY TO CONSTRUCT A TYPE **A** HOUSE.

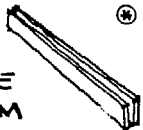
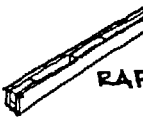

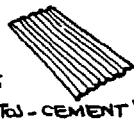
TYPE OF PART	DIMENSIONS (cm)	QUANTITY
--------------	-----------------	----------

 PILES	ϕ 15 TO 20	12
 MAIN BEAMS	5 x 20 x 400	5
 JOISTS	5 x 15 x 300	20
 STIFFENING CROSS PIECE	5 x 7,5 x 400	5
 FLOOR BOARD	2,5 x 20 x 300	50
 SINGLE PANEL [⊛]	55 x 240	19
 OPEN PANEL FOR KITCHEN WINDOW [⊙]	85 x 240	2
 OPEN PANEL FOR LIVING OR BEDROOM WINDOW [⊙]	85 x 240	2
 OPEN PANEL FOR DOOR [⊙]	85 x 240	3
 INTER-PANEL STUDS [⊛]	5 x 5 x 232,5	2
	5 x 5 x 240	4
	5 x 5 x 325	4
 PORCH SUPPORT POST [⊙]	5 x 7,5 x 265	2
	5 x 5 x 232,5	2
 PORCH BEAM [⊛]	5 x 7,5 x 232,5	2

TYPE OF PART	DIMENSIONS (cm)	QUANTITY
--------------	-----------------	----------

 TOP PLATE	5 x 7,5 x 175	3
	5 x 7,5 x 265	4
	5 x 7,5 x 640	2
 RIDGE BEAM [⊛]	l = 180 cm	—
	l = 197,5 cm	2
	l = 245 cm	1
 RAFTER [⊛]	l = 330 cm	18
 PURLIN	5 x 5 x 640	8
 FACING BOARD	2,5 x 7,5 x 330	4
	2,5 x 7,5 x 640	2
 TILE (ASBESTOS-CEMENT)	LENGTH = 122 cm WIDTH = 50,6 cm THICKNESS = 0,4 cm	90
 RIDGE TILE	LENGTH = 102 cm WIDTH = 41,5 cm THICKNESS = 0,5 cm	15
 JOIST HEADER BOARD	2,5 x 20 x 545	2
 INTER PANEL FINISHING	125 x 20 x 250	31
	1,25 x 5 x 250	6
 DOOR [⊙]	75 x 215	3
 KITCHEN WINDOW [⊙]	75 x 90	2
 LIVING ROOM OR BEDROOM WINDOW [⊙]	75 x 1	2

WHEN AN ASTERISK [⊛] IS INDICATED YOU SHOULD LOOK FOR A DESCRIPTION OF THE PIECES IN THE SECTION "HOW TO MAKE THE PARTS OF THE HOUSE"

THE SUMMARY BELOW IS INTENDED TO HELP YOU ORDER
OR CUT THE MATERIALS NECESSARY TO CONSTRUCT A TYPE
A HOUSE



DIMENSIONS (cm)	QUANTITY	COST
ϕ 15 TO 20 (PILES)	12	
5 x 20 x 400	5	
5 x 15 x 300	20	
2,5 x 20 x 300	56	
1,25 x 20 x 250	31	
1,25 x 20 x 247,5	95	
1,25 x 20 x 132,5	10	
1,25 x 20 x 97,5	10	
1,25 x 20 x 25	35	
5 x 5 x 320	16	
5 x 5 x 325	4	
5 x 5 x 240	52	
5 x 5 x 232,5	4	
5 x 5 x 75	119	
5 x 5 x 60	18	
5 x 5 x 35	48	
5 x 5 x 30	18	
5 x 7,5 x 400	8	
5 x 7,5 x 265	6	
5 x 7,5 x 232,5	2	
5 x 7,5 x 175	3	
5 x 7,5 x 60	2	
5 x 7,5 x 20	4	

DIMENSIONS (cm)	QUANTITY	COST
2,5 x 10 x 245	2	
2,5 x 10 x 197,5	4	
2,5 x 7,5 x 330	4	
1,25 x 5 x 250	6	
1,25 x 5 x 222,5	6	
1,25 x 5 x 125	4	
1,25 x 5 x 90	4	
1,25 x 5 x 12,5	120	
l = 10 cm NAILS	538	
l = 6,25 cm NAILS	476	
l = 5 cm NAILS	1381	

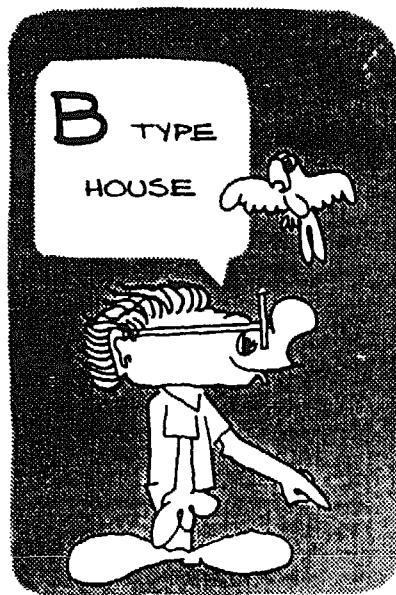



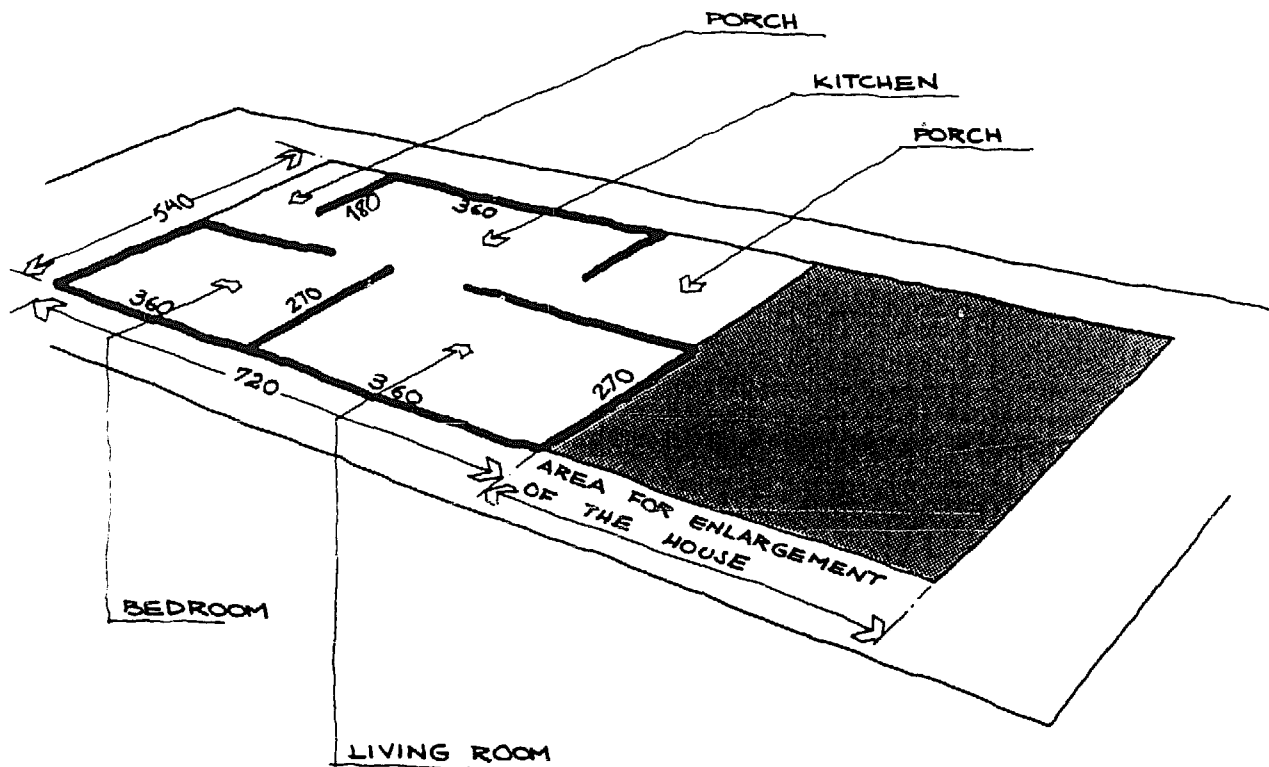





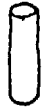
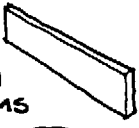
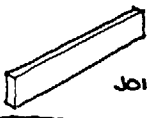





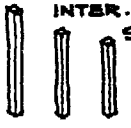



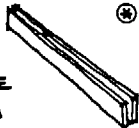
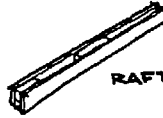

HERE ARE THE
DIMENSIONS
AND QUANTITIES
OF THE DIFFER-
-ENT PIECES
NECESSARY TO
CONSTRUCT A
TYPE **B**
HOUSE



TYPE OF PART	DIMENSIONS (cm)	QUANTITY
--------------	-----------------	----------

TYPE OF PART	DIMENSIONS (cm)	QUANTITY
--------------	-----------------	----------

 PILES	ϕ 15 TO 20	15
 MAIN BEAMS	5 x 20 x 400	6
 JOISTS	5 x 15 x 300	26
 STIFFENING CROSS PIECES	5 x 7,5 x 400	6
 FLOOR BOARD	2,5 x 20 x 300	66
 SINGLE PANEL	85 x 240	25
 OPEN PANEL FOR KITCHEN WINDOW	85 x 240	2
 OPEN PANEL FOR LIVING OR BEDROOM WINDOW	85 x 240	4
 OPEN PANEL FOR DOOR	85 x 240	4
 INTER-PANEL STUDS	5 x 5 x 232,5	2
	5 x 5 x 240	6
	5 x 5 x 325	5
 PORCH SUPPORT POST	5 x 7,5 x 265	2
	5 x 5 x 232,5	2
 PORCH BEAM	5 x 7,5 x 232,5	2

 TOP PLATE	5 x 7,5 x 175	4
	5 x 7,5 x 265	5
	5 x 7,5 x 820	2
 RIDGE BEAM	l = 180 cm	1
	l = 197,5 cm	2
	l = 245 cm	1
 RAFTER	l = 330 cm	22
 PURLIN	5 x 5 x 820	8
 FACING BOARD	2,5 x 7,5 x 330	4
	2,5 x 7,5 x 820	2
 TILE (ASBESTOS-CEMENT)	LENGTH = 122 cm WIDTH = 50,6 cm THICKNESS = 0,4 cm	114
 RIDGE TILE	LENGTH = 102 cm WIDTH = 41,5 cm THICKNESS = 0,5 cm	19
 JOISTS HEADER BOARD	2,5 x 20 x 545	2
 INTER-PANEL FINISHING	1,25 x 20 x 250	31
	1,25 x 5 x 250	6
 DOOR	75 x 215	3
 KITCHEN WINDOW	75 x 90	2
 LIVING ROOM OR BEDROOM WINDOW	75 x 125	2

WHEN AN ASTERISK * IS INDICATED, YOU SHOULD LOOK FOR A DESCRIPTION OF THE PIECES IN THE SECTION "HOW TO MAKE THE PARTS OF THE HOUSE".

THE SUMMARY BELOW IS INTENDED TO HELP YOU ORDER OR CUT THE MATERIALS NECESSARY TO CONSTRUCT A TYPE

B HOUSE







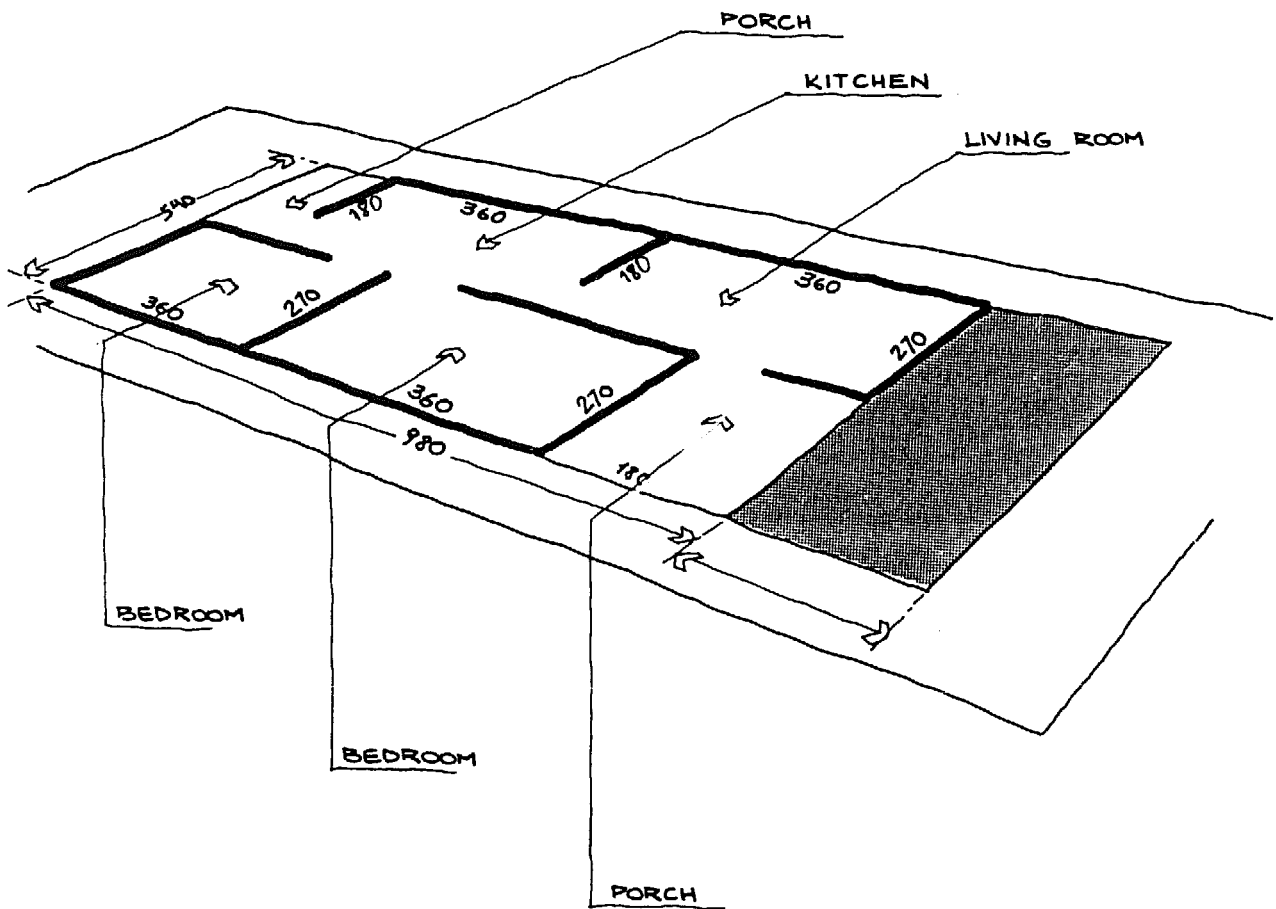
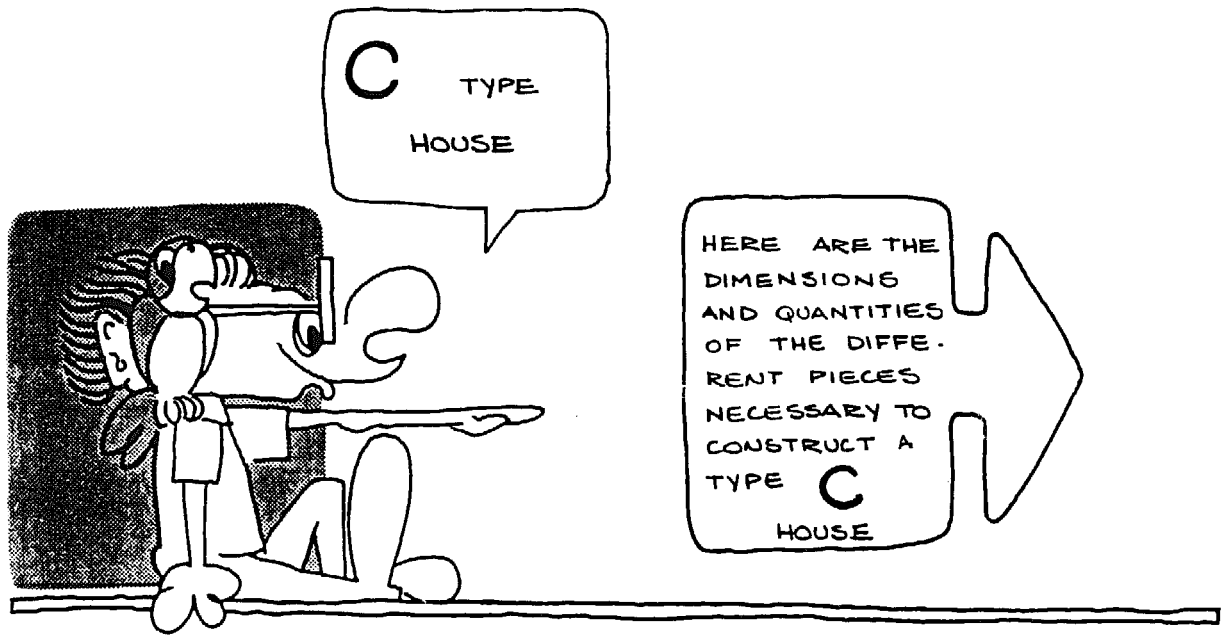



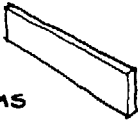

DIMENSIONS (cm)	QUANTITY	COST
∅ 15 x 20 (PILES)	15	
5 x 20 x 400	6	
5 x 15 x 300	26	
2,5 x 20 x 300	72	
1,25 x 20 x 250	39	
1,25 x 20 x 247,5	125	
1,25 x 20 x 132,5	10	
1,25 x 20 x 97,5	20	
1,25 x 20 x 25	50	
5 x 5 x 325	5	
5 x 5 x 320	16	
5 x 5 x 240	76	
5 x 5 x 232,5	4	
5 x 5 x 180	8	
5 x 5 x 75	159	
5 x 5 x 60	22	
5 x 5 x 35	57	
5 x 5 x 30	22	
5 x 7,5 x 400	11	
5 x 7,5 x 232,5	2	
5 x 7,5 x 175	4	
5 x 7,5 x 60	3	
5 x 7,5 x 20	5	









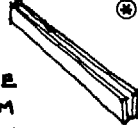

DIMENSIONS (cm)	QUANTITY	COST
2,5 x 10 x 245	2	
2,5 x 10 x 197,5	4	
2,5 x 10 x 180	2	
2,5 x 7,5 x 330	54	
1,25 x 5 x 250	6	
1,25 x 5 x 222,5	8	
1,25 x 5 x 125	8	
1,25 x 5 x 90	4	
1,25 x 5 x 12,5	164	
l = 10 cm NAIL	638	
l = 6,25 cm NAIL	636	
l = 5 cm NAIL	1857	



TYPE OF PART	DIMENSIONS (cm)	QUAN- TITY
--------------	-----------------	------------

TYPE OF PART	DIMENSIONS (cm)	QUAN- TITY
--------------	-----------------	------------

 PILES	ϕ 15 TO 20	18
 MAIN BEAMS	5 x 20 x 400	8
 JOISTS	5 x 15 x 300	32
 STIFFENING CROSS PIECES	5 x 7,5 x 400	8
 FLOOR BOARDS	2,5 x 20 x 300	83
 SINGLE PANEL	85 x 240	29
 OPEN PANEL FOR KITCHEN WINDOW	85 x 240	2
 OPEN PANEL FOR LIVING OR BEDROOM WINDOW	85 x 240	8
 OPEN PANEL FOR DOOR	85 x 240	5
 INTER-PANEL STUDS	5 x 5 x 232,5	2
	5 x 5 x 240	8
	5 x 5 x 325	6
 PORCH SUPPORT POST	5 x 7,5 x 265	2
	5 x 5 x 232,5	2
 PORCH BEAM	5 x 7,5 x 232,5	2

 TOP PLATE	5 x 7,5 x 175	5
	5 x 7,5 x 265	6
	5 x 7,5 x 1000	2
 RIDGE BEAM	l = 180 cm	2
	l = 197,5 cm	2
	l = 245 cm	1
 RAFTER	l = 330 cm	26
 PURLIN	5 x 5 x 1000	8
 FACING BOARD	2,5 x 7,5 x 330	4
	2,5 x 7,5 x 1000	2
 TILE (ASBESTOS-CEMENT)	LENGTH = 122 cm	138
	WIDTH = 50,6 cm	
	THICKNESS = 0,4 cm	
 RIDGE TILE	LENGTH = 102 cm	2
	WIDTH = 41,5	
	THICKNESS = 0,5 cm	
 JOISTS HEADER BOARD	1,25 x 20 x 905	2
 INTER-PANEL FINISHING	1,25 x 20 x 250	47
	1,25 x 5 x 250	6
 DOOR	75 x 215	5
 KITCHEN WINDOW	75 x 90	2
 LIVING ROOM OR BEDROOM WINDOW	75 x 125	8

WHEN AN ASTERISK * IS INDICATED YOU SHOULD LOOK FOR A DESCRIPTION OF THE PIECES IN THE SECTION "HOW TO MAKE THE PARTS OF THE HOUSE".

THE SUMMARY BELOW IS INTENDED TO HELP YOU ORDER
OR CUT MATERIALS NECESSARY TO CONSTRUCT TYPE
C HOUSE.



DIMENSIONS (cm)	QUANTITY	COST
ϕ 15 ^{to} 20 (PILES)	18	
5 x 20 x 400	8	
5 x 15 x 300	32	
2,5 x 20 x 300	90	
1,25 x 20 x 250	47	
1,25 x 20 x 247,5	145	
1,25 x 20 x 132,5	10	
1,25 x 20 x 97,5	40	
1,25 x 20 x 25	75	
5 x 5 x 325	6	
5 x 5 x 320	16	
5 x 5 x 240	88	
5 x 5 x 232,5	4	
5 x 5 x 180	16	
5 x 5 x 75	197	
5 x 5 x 60	26	
5 x 5 x 35	74	
5 x 5 x 30	26	
5 x 7,5 x 400	13	
5 x 7,5 x 265	8	
5 x 7,5 x 232,5	2	
5 x 7,5 x 175	5	
5 x 7,5 x 60	4	
5 x 7,5 x 20	6	

<u>DIMENSIONS (cm)</u>	<u>QUANTITY</u>	<u>COST</u>
2,5 x 10 x 245	2	
2,5 x 10 x 197,5	4	
2,5 x 10 x 180	4	
2,5 x 7,5 x 330	62	
<hr/>		
1,25 x 5 x 250	6	
1,25 x 5 x 222,5	10	
1,25 x 5 x 125	16	
1,25 x 5 x 90	4	
<hr/>		
1,25 x 5 x 12,5	216	
<hr/>		
l = 10 cm NAIL	778	
l = 6,25 cm NAIL	788	
l = 5 cm NAIL	2347	

D
TYPE
HOUSE

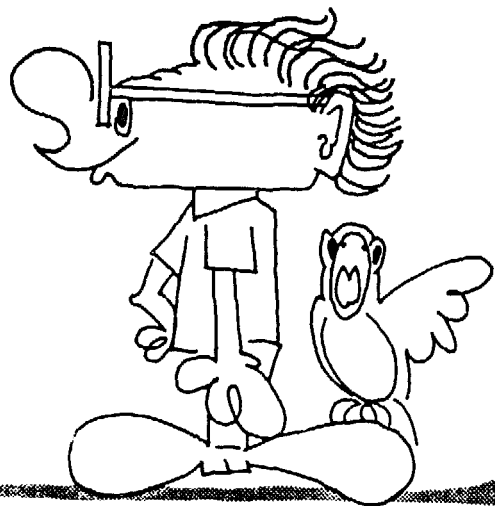



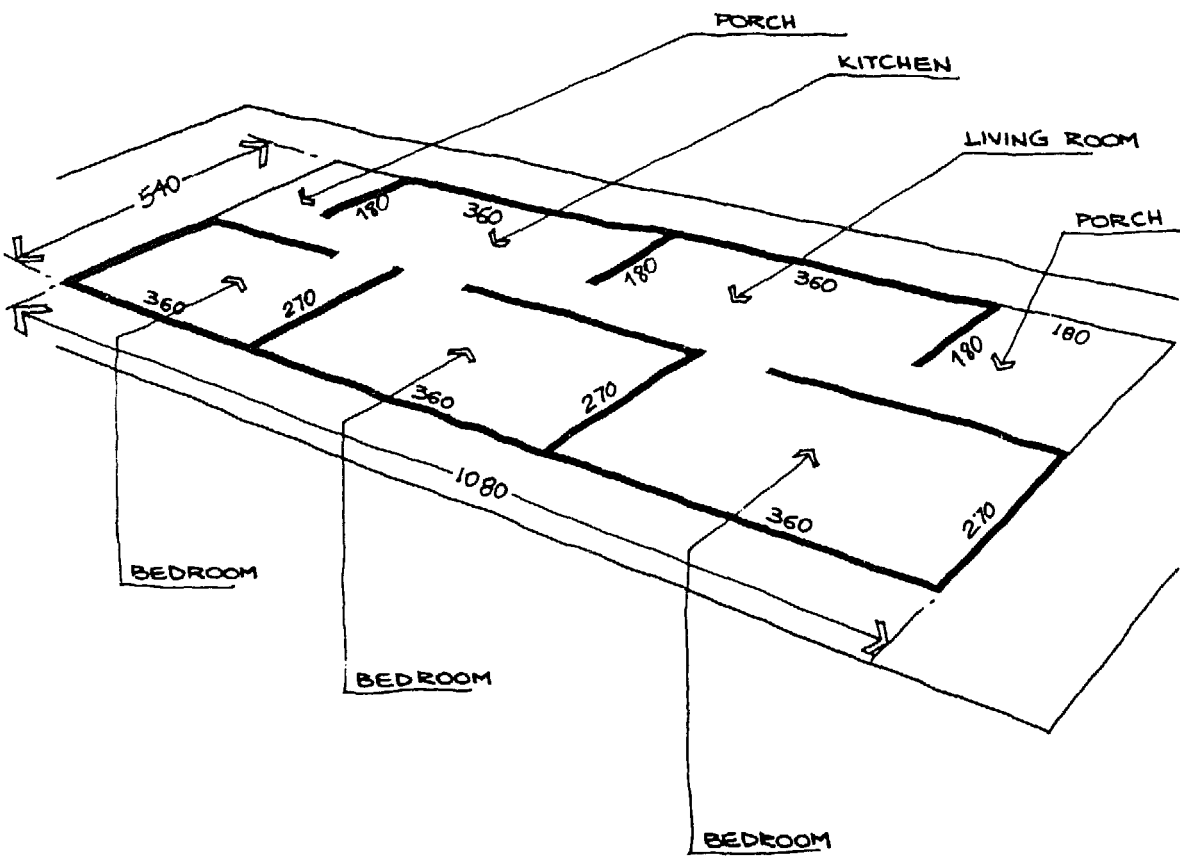





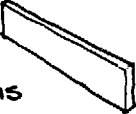











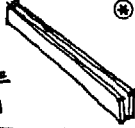

HERE ARE THE
DIMENSIONS AND
QUANTITIES OF
THE DIFFERENT
PIECES NECESSARY
TO CONSTRUCT A
TYPE D
HOUSE

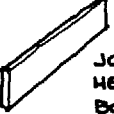

TYPE OF PART	DIMENSIONS (cm)	QUANTITY
--------------	-----------------	----------

TYPE OF PART	DIMENSIONS (cm)	QUANTITY
--------------	-----------------	----------

 PILES	ϕ 15 to 20	21
 MAIN BEAMS	5 x 20 x 400	9
 JOISTS	5 x 15 x 300	38
 STIFFENING CROSS PIECES	5 x 7,5 x 400	9
 FLOOR BOARD	2,5 x 20 x 300	99
 SINGLE PANEL	85 x 240	35
 OPEN PANEL FOR KITCHEN WINDOW	85 x 240	2
 OPEN PANEL FOR LIVING OR BEDROOM WINDOW	85 x 240	10
 OPEN PANEL FOR DOOR	85 x 240	6
 INTER-PANEL STUDS	5 x 5 x 232,5	2
	5 x 5 x 240	10
	5 x 5 x 325	7
 PORCH SUPPORT POST	5 x 7,5 x 265	2
	5 x 5 x 232,5	2
 PORCH BEAM	5 x 7,5 x 232,5	2

 TOP PLATE	5 x 7,5 x 175	6
	5 x 7,5 x 265	7
	5 x 7,5 x 1180	2
 RIDGE BEAM	l = 180 cm	3
	l = 197,5 cm	2
	l = 245 cm	1
 RAFTER	l = 330 cm	30
 PURLIN	5 x 5 x 1180	8
 FACING BOARD	2,5 x 7,5 x 330	4
	2,5 x 7,5 x 1180	2
 TILE (ASBESTOS CEMENT)	LENGTH = 122 cm WIDTH = 50,6 cm THICKNESS = 0,4 cm	162
 RIDGE TILE	LENGTH = 102 cm WIDTH = 41,5 cm THICKNESS = 0,5 cm	27
 JOIST HEADER BOARD	2,5 x 20 x 1085	2
 INTER-PANEL FINISHING	1,25 x 20 x 250	35
	1,25 x 5 x 250	6
 DOOR	75 x 215	6
 KITCHEN WINDOW	75 x 90	2
 LIVING ROOM OR BEDROOM WINDOW	75 x 125	10

WHEN AN ASTERISK * IS INDICATED YOU SHOULD LOOK FOR A DESCRIPTION OF THE PIECES IN THE SECTION "HOW TO MAKE THE PARTS OF THE HOUSE".

THE SUMMARY BELOW IS INTENDED TO HELP YOU ORDER OR CUT MATERIALS NECESSARY TO CONSTRUCT TYPE **D** HOUSE



DIMENSIONS (cm)	QUANTITY	COST
ϕ 15 ^{TO} 20 (PILES)	21	
5 x 20 x 400	9	
5 x 20 x 300	38	
2,5 x 20 x 300	107	
1,25 x 20 x 250	55	
1,25 x 20 x 247,5	175	
1,25 x 20 x 132,5	10	
1,25 x 20 x 97,5	50	
1,25 x 20 x 25	90	
5 x 5 x 325	7	
5 x 5 x 320	16	
5 x 5 x 240	116	
5 x 5 x 232,5	4	
5 x 5 x 180	24	
5 x 5 x 75	237	
5 x 5 x 60	30	
5 x 5 x 35	87	
5 x 5 x 30	30	
5 x 7,5 x 400	15	
5 x 7,5 x 265	9	
5 x 7,5 x 232,5	2	
5 x 7,5 x 175	6	
5 x 7,5 x 60	5	
5 x 7,5 x 20	7	

DIMENSIONS (cm)	QUANTITY	COST
2,5 x 10 x 245	2	
2,5 x 10 x 197,5	4	
2,5 x 10 x 180	6	
2,5 x 7,5 x 330	72	
<hr/>		
1,25 x 5 x 250	6	
1,25 x 5 x 222,5	12	
1,25 x 5 x 125	20	
1,25 x 5 x 90	4	
<hr/>		
1,25 x 5 x 12,5	260	
<hr/>		
l = 10 cm NAIL	922	
l = 6,25 cm NAIL	948	
l = 5 cm NAIL	2823	

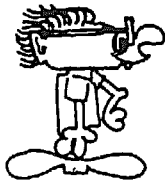

HOW TO LOCATE THE HOUSE ON YOUR PLOT.

YOUR PLOT AREA MUST BE LARGE ENOUGH TO GIVE THE MINIMUM UNBUILT SPACE AS DESCRIBED HERE. THERE SHOULD ALSO BE SPACE LEFT FOR FUTURE POSSIBLE EXTENSION.

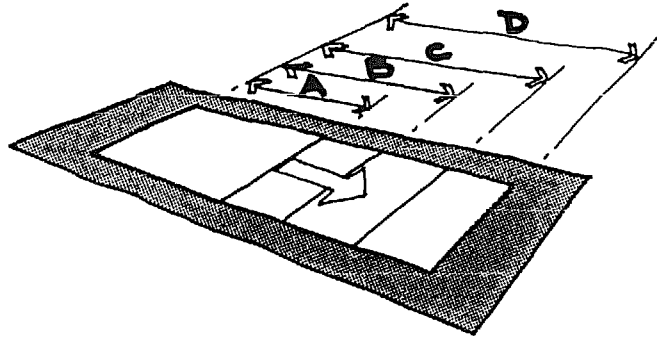

IN ORDER TO REDUCE THE DANGER OF A FIRE SPREADING FROM YOUR NEIGHBOUR'S HOUSE TO YOUR HOME, THE HOUSE SHOULD NOT BE BUILT NEXT TO THE BOUNDARIES OF THE PLOT.

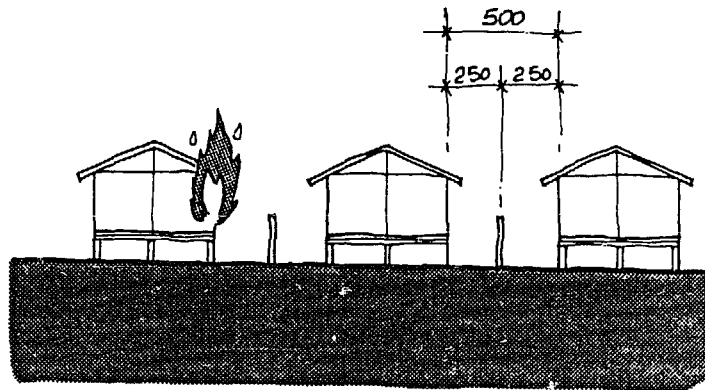

BESIDES YOU SHOULD NOT ERECT YOUR HOUSE TOO CLOSE TO THE FENCES BECAUSE YOU WILL NEED SPACE TO...

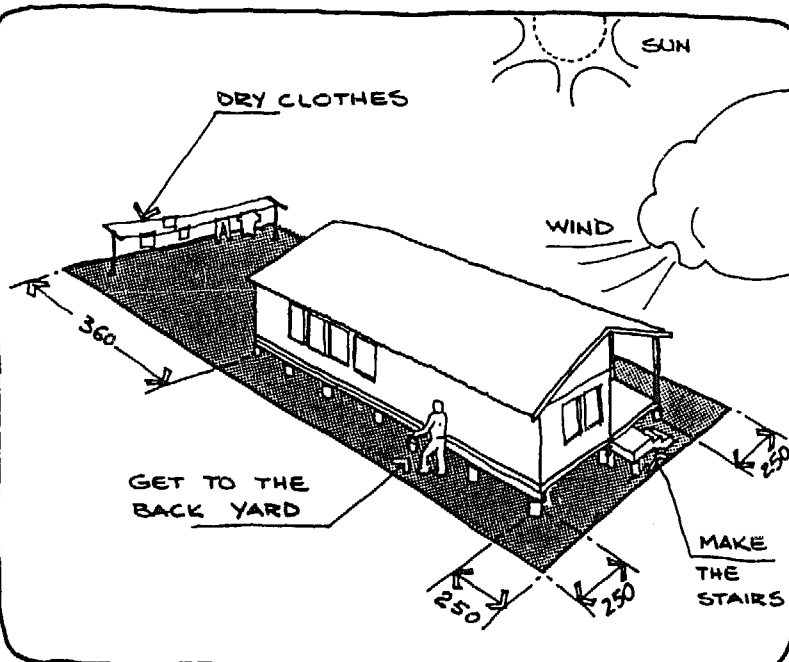

WHAT TO DO

... IF YOUR PLOT IS FLAT OR ONLY SLIGHTLY SLOPING.

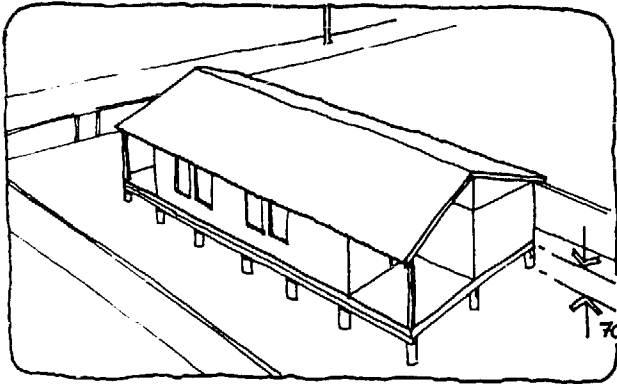

YOU MUST BUILD THE FLOOR OF THE HOUSE AT LEAST 70 cm ABOVE GROUND.



... IF YOUR PLOT IS SWAMPY

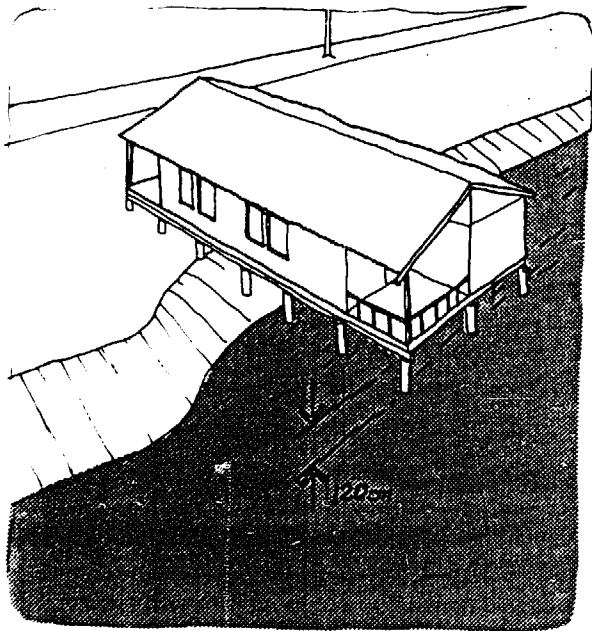

YOU MUST PUT THE PILES AT LEAST 120 cm HIGHER THAN THE MINIMUM FLOOD-WATER HEIGHT. DON'T FORGET TO CROSS BRACE THE PILES TO AVOID POSSIBLE INSTABILITY DUE TO WATER FLOW UNDERNEATH THE HOUSE.

IF YOUR PLOT IS SLOPING
SPECIAL CARE IS NEEDED.

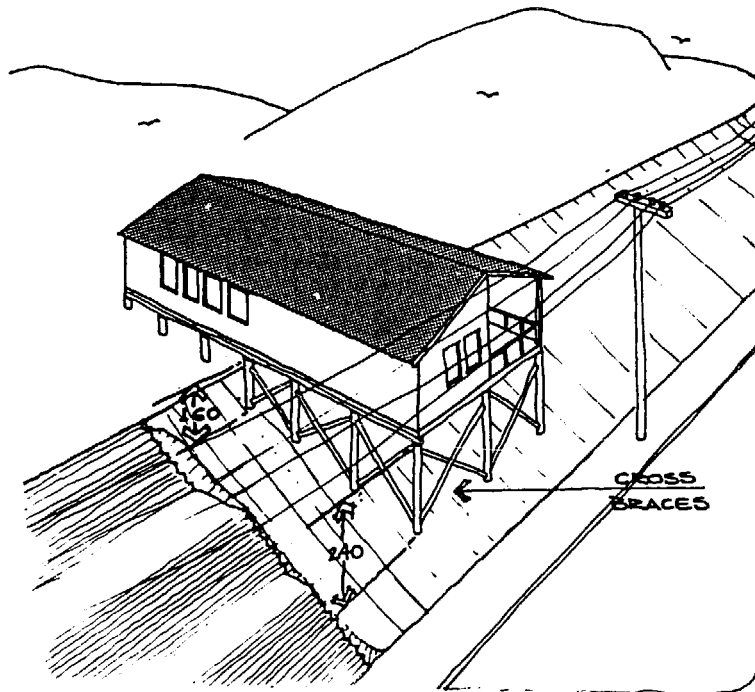

PILES HIGHER THAN 160 cm
BUT LESS THAN 240 cm MUST
BE CROSS BRACED. ABOVE
240 cm YOU MUST CONSULT
A TECHNICIAN TO ENSURE
ADEQUATE SAFETY.

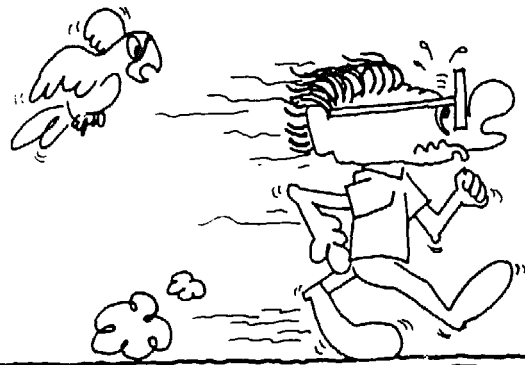

LOCATION OF TOILET AND BATH FACILITIES

THE COMPLETE
BATHROOM AND
TOILET CAN BE
CONSTRUCTED
IN THE BACK
YARD OR ...

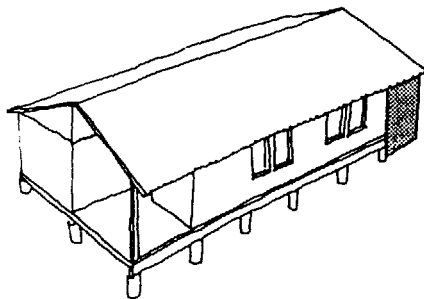
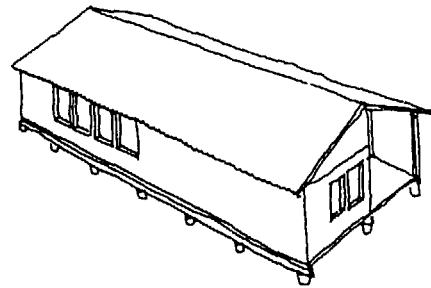

... CLOSE TO THE HOUSE
IN THE SPACE RESERVED
FOR THE BACK PORCH. IN
THIS CASE IT WOULD BE
BETTER TO USE BRICKS.

YOU MAY ALSO INSTALL A
SEPARATE SHED FOR
STORAGE AND OUTSIDE WORK

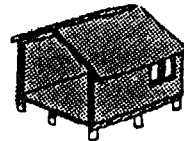
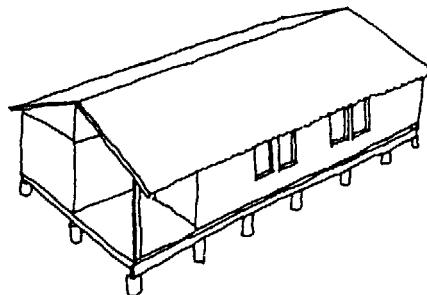

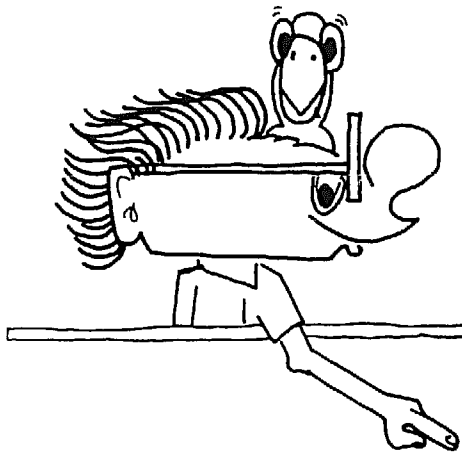

HERE ARE SOME
MODIFICATIONS YOU CAN
MAKE TO YOUR HOUSE

ATTENTION. THESE ARE THE MODIFICATIONS YOU CAN DO YOURSELF, BUT IT'S BETTER TO CONSULT A TECHNICIAN FIRST TO MAKE SURE YOU'RE DOING IT PROPERLY

IN PLACE OF THE PILES YOU CAN BUILD THE FOUNDATIONS WITH MASONRY AND THE FLOOR CAN BE A CONCRETE SLAB. REMEMBER THAT THE HOUSE SHOULD BE PROPERLY ANCHORED INTO THE FOUNDATIONS.

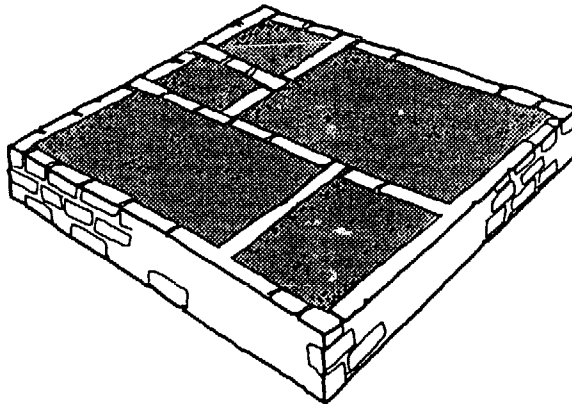

BATHROOM
CONSTRUCTED WITH
BRICKS CLOSE TO
THE HOUSE.

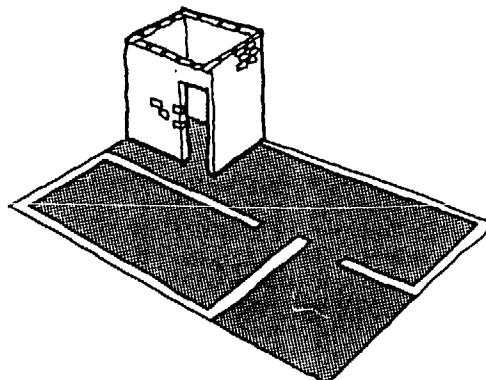

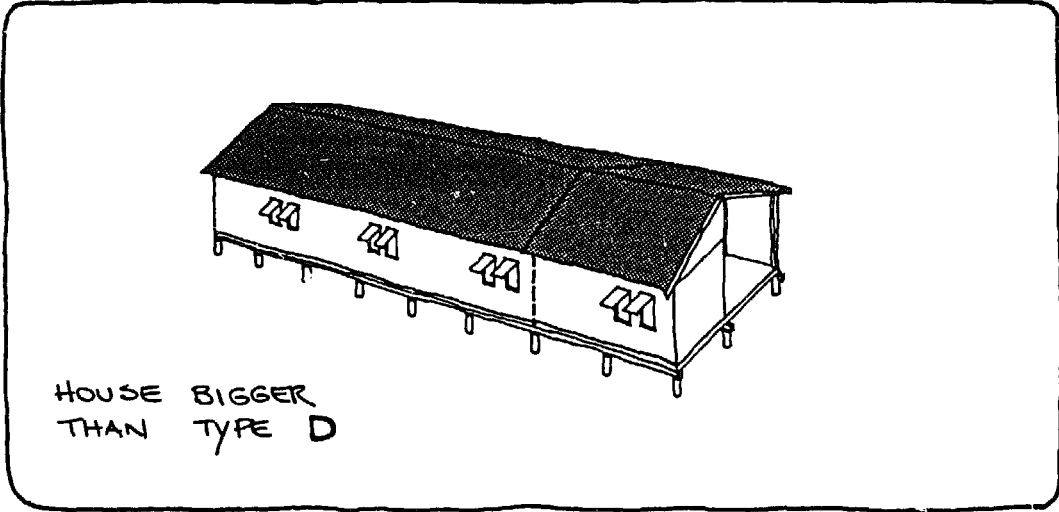

OR IF THE PLOT
ALLOWS, A HOUSE
WITH AN EXTENSION
ON THE SIDE

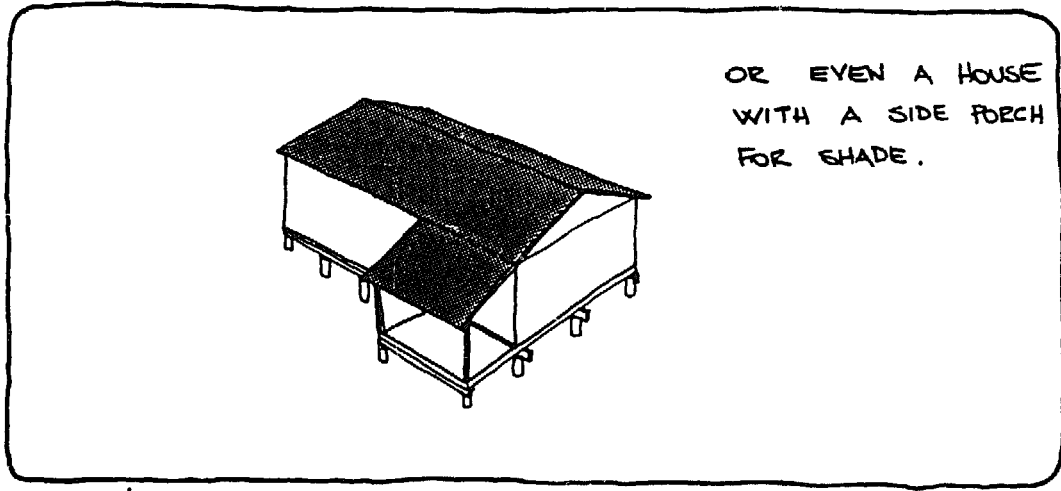
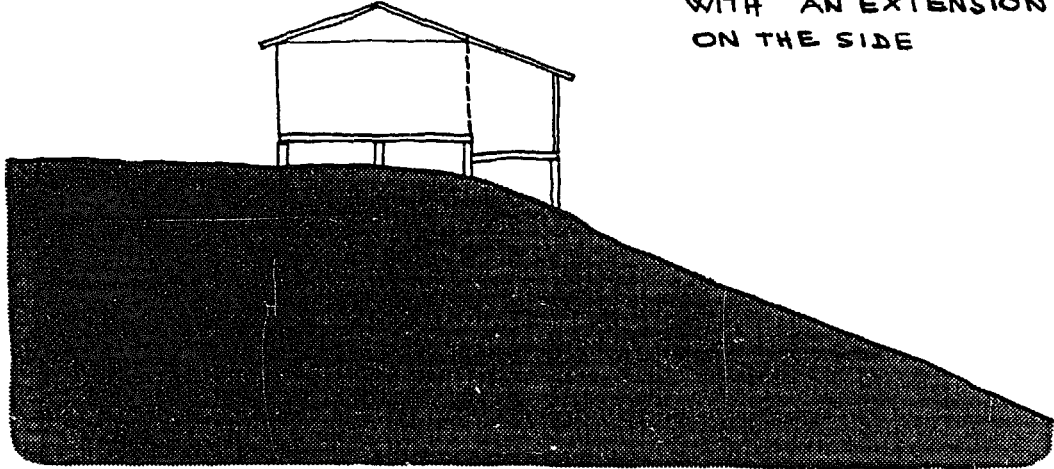

- AND FURTHER ...
- PUT A CEILING UNDER THE ROOF
- PUT PANNELING ON INSIDE WALLS
- COVER THE FLOOR TO KEEP OUT DUST AND INSECTS, AND ALSO FOR MORE COMFORT.

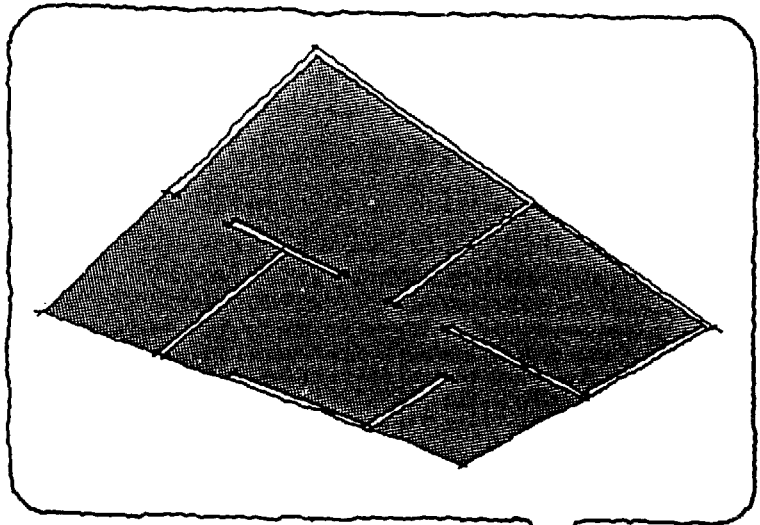

THE ROOF CAN BE MADE OF CORRUGATED ALUMINIUM OR GALVANIZED CORRUGATED IRON SHEETS OR VEGETABLE FIBER PANELS OR ANY OTHER KIND OF ROOFING MATERIAL LOCALLY AVAILABLE

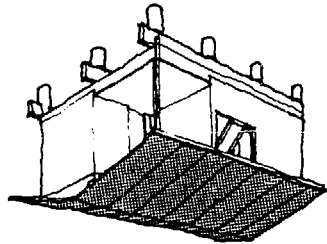

CHANGE THE POSITION OF THE DOORS OR INCLUDE MORE DOORS.

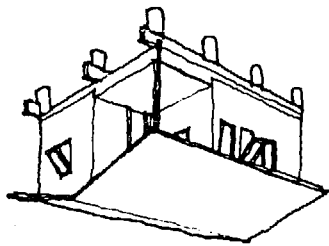

CHANGE THE POSITION AND THE NUMBER OF THE WINDOWS, THE TYPE AND QUALITY OF THE FRAMES TO IMPROVE THE ASPECT OF THE HOUSE, THE VENTILATION OR WIND AND RAIN PROTECTION.

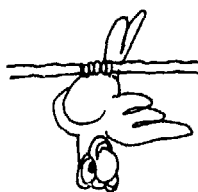
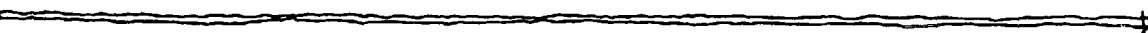
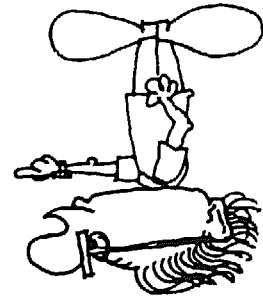

THESE MODIFICATIONS CAN BE MADE WITHOUT SPECIFIC TECHNICAL ASSISTANCE.

THE BEST WAY TO BUILD THE HOUSE

READ THIS LITTLE BOOK
CAREFULLY AND DO
EVERYTHING EXACTLY
AS DESCRIBED HERE.

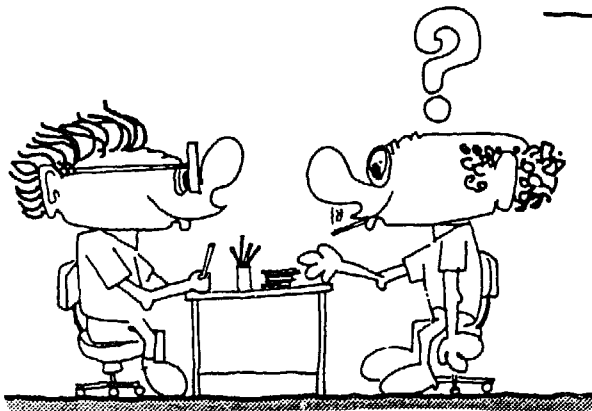

ASK FOR ADVICE FROM PEOPLE
EXPERIENCED IN CONSTRUCTION
JOBS IN ORDER TO CLEAR UP
DOUBTS ABOUT THE HOUSE AND
ALSO TO DISCUSS MODIFICA-
TIONS YOU MAY WANT TO MAKE.

WHEN SOME NEIGHBOURS OR FRIENDS DECIDE TO BUILD
THEIR HOUSES AT THE SAME TIME, THE CONSTRUCTION
OF ALL HOUSES BECOMES EASIER IF THE FAMILIES
GET TOGETHER AND CO-OPERATE.

YOU CAN ORGANIZE THE WORK SO THAT EVERYBODY
HELPS TO MAKE THE PIECES (PANELS, BEAMS ETC.),
THEN EVERYBODY HELPS TO ASSEMBLE THE HOUSES.
THIS WAY, YOU CAN SHARE TASKS AND FINISH THE
WORK FASTER. TO ORGANIZE THE WORK IN THIS MANNER, ASK
FOR HELP FROM PEOPLE WITH EXPERIENCE IN
CONSTRUCTION.

HOW TO MAKE THE PARTS OF THE HOUSE

NOW WE ARE GOING TO SHOW HOW TO MAKE AND ASSEMBLE ALL THOSE PIECES, WE ARE ALSO GOING TO SHOW THE TOOLS AND THE WORKBENCH WHICH YOU WILL NEED TO MAKE THE PIECES. YOU CAN MAKE THESE PIECES YOURSELF OR THEY CAN BE ORDERED FROM A CARPENTER. IF SEVERAL FAMILIES GET TOGETHER TO ORDER THE PIECES FOR ALL THE HOUSES, THE CARPENTER MAY GIVE YOU A BETTER PRICE ...

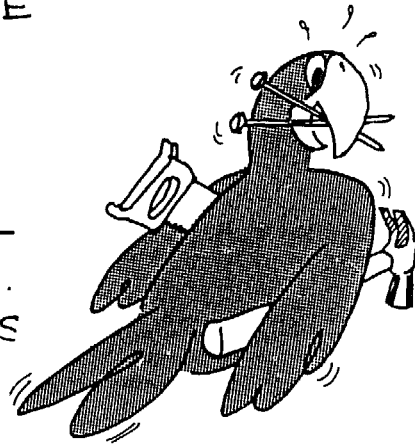

... IF YOU PREFER YOU CAN BUY UNCUT TIMBER, SAW IT INTO THE RIGHT SIZES, THEN MAKE THE PIECES.

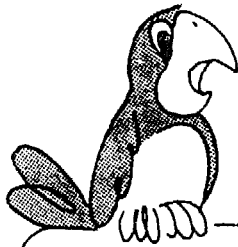

THE TOOLS SHOWN BELOW ARE INTENDED FOR BOTH SHAPING THE PIECES AND FOR ASSEMBLING THE HOUSE.



TAPE MEASURE



LINE OR WIRE

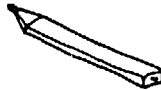

CARPENTER'S PENCIL



FOLDING RULER

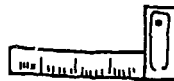

SQUARE



RULER



PLUMB BOB



CLAW HAMMER

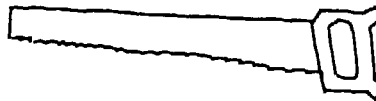

HAND SAW



RASP



PLANE



POST HOLE
DIGGER

IF YOU ALREADY HAVE TOOLS, FOR EXAMPLE AN ELECTRIC SAW, YOUR TASK WILL BE EASIER. YOUR WORK WILL ALSO BE EASIER IF YOU FORM GROUPS WITH OTHER PEOPLE WHO ARE GOING TO MAKE THEIR OWN HOUSES, TOO. THESE GROUPS CAN HIRE TOOLS OR LEASE A WORKSHOP.

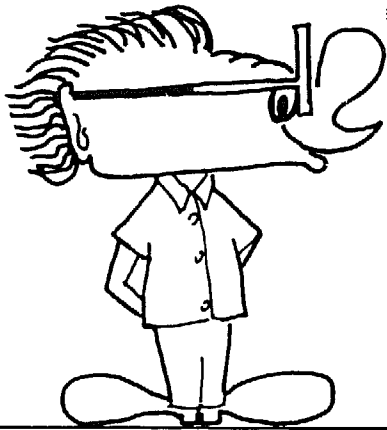

FOR SHAPING AND ASSEMBLING THE PARTS YOU ARE ADVISED TO BUILD A BENCH WHERE JIGS CAN BE PLACED SO AS TO SIMPLIFY MAKING MEASUREMENTS.

FIRST YOU MAKE THE WORKBENCH, STAYS OR WOODEN HORSES. THE VERTICAL SUPPORTS CAN BE FIXED INTO THE GROUND ...

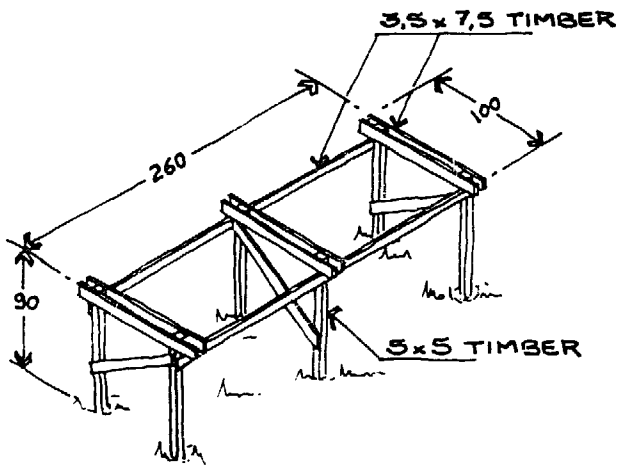

... OR CAN STAY FREE, SO YOU CAN SHIFT THE BENCH FROM PLACE TO PLACE.

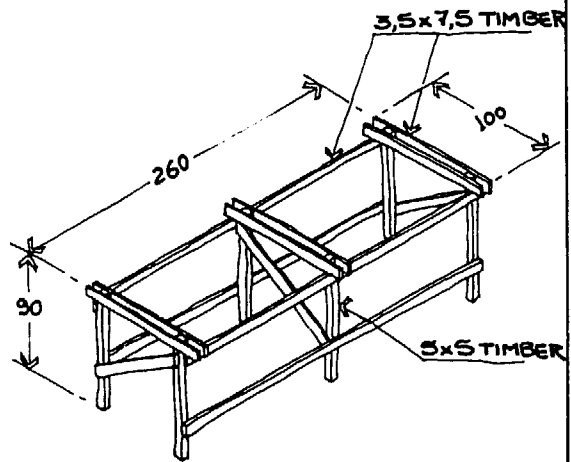

YOU NAIL BOARDS ON TOP OF THIS STRUCTURE.

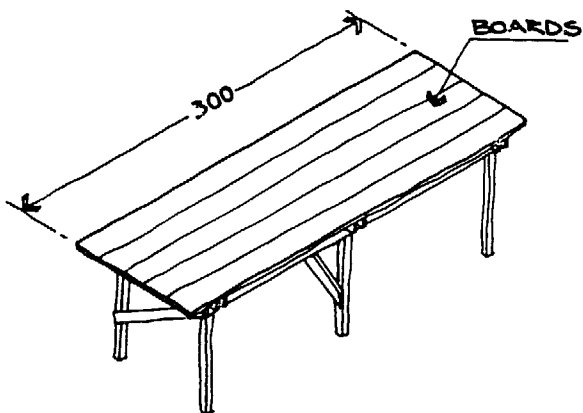

NEXT YOU MARK THE DIMENSION OR LENGTH OF THE PIECE ON THE BENCH TOP AND NAIL THE STOPS, SO YOU MAKE ALL THE PIECES ALIKE.

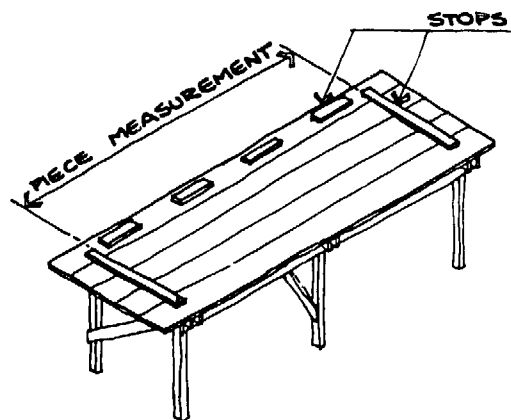

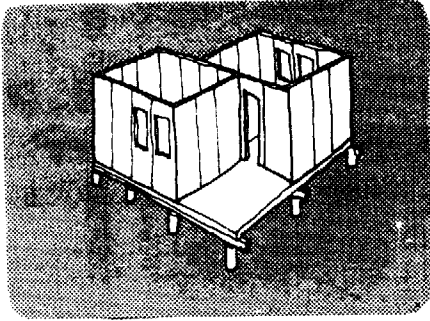

LET'S LOOK AT THE PANELS

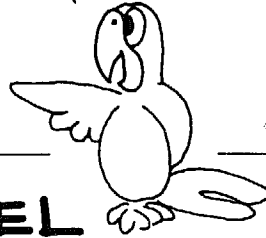

HOW TO MAKE THE PANELS

YOU ALREADY KNOW WHICH TYPES OF PANELS ARE NEEDED. HERE WE ARE GOING TO SHOW HOW THEY ARE MADE.

SINGLE PANEL

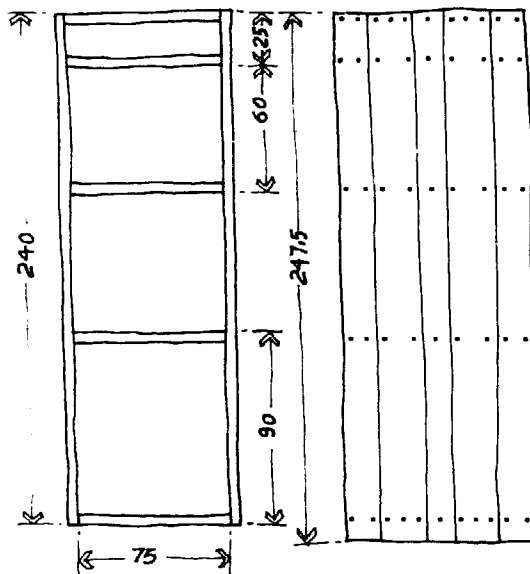

FRAMEWORK

PANEL FRONT VIEW

LIST OF MATERIALS:

FRAME

02	5x5 x 240 cm	TIMBER
05	5x5 x 75 cm	TIMBER
20	l = 6,25 cm	NAILS
10	l = 10 cm	NAILS

COVERING

04	1,25 x 5 x 12,5 cm	TIMBER
05	1,25 x 20 x 247,5 cm	TIMBER
53	l = 5 cm	NAILS

OPEN PANEL FOR LIVING OR BEDROOM WINDOW

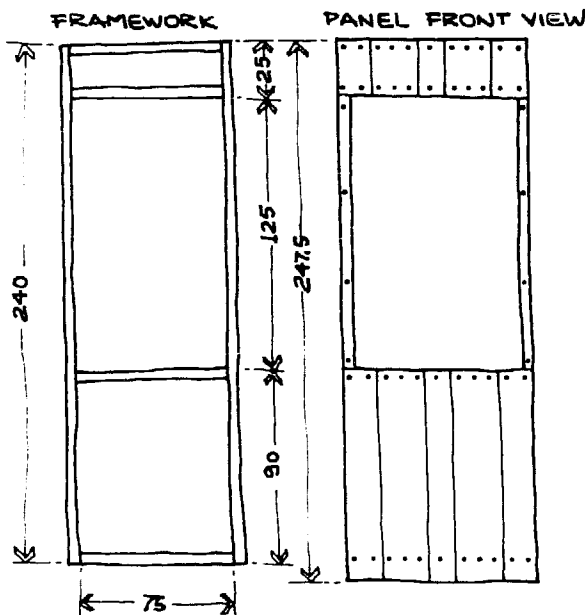

FRAMEWORK

PANEL FRONT VIEW

LIST OF MATERIALS:

FRAME

02	5x5 x 240 cm	TIMBER
04	5x5 x 75 cm	TIMBER
16	l = 6,25 cm	NAILS
08	l = 10 cm	NAILS

COVERING

08	1,25 x 5 x 12,5 cm	TIMBER
02	1,25 x 5 x 12,5 cm	TIMBER
05	1,25 x 20 x 25 cm	TIMBER
05	1,25 x 20 x 97,5	TIMBER
60	l = 5 cm	NAILS

OPEN PANEL FOR KITCHEN WINDOW

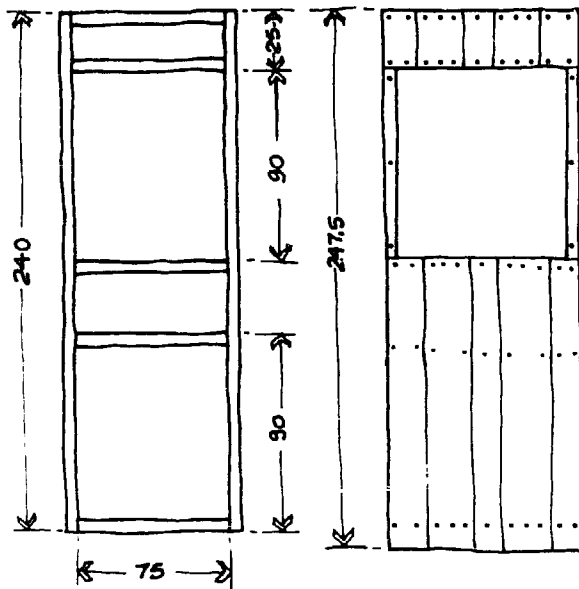

FRAMEWORK

PANEL FRONT VIEW

LIST OF MATERIALS:

FRAME

02	5x5x240 cm	TIMBER
02	5x5x75 cm	TIMBER
20	l=6,25 cm	NAILS
10	l=10 cm	NAILS

COVERING

08	1,25x5x12,5 cm	TIMBER
02	1,25x5x90 cm	TIMBER
05	1,25x20x132,5 cm	TIMBER
05	1,25x5x25 cm	TIMBER
67	l=5 cm	NAILS

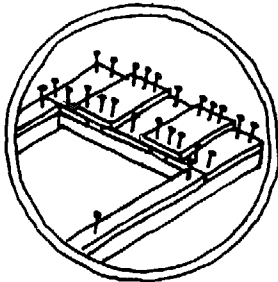

YOU SHOULD REINFORCE THE BORDER OF THE PANEL WITH MORE NAILS



DON'T FORGET TO CROSS BRACE THE PANEL TO AVOID ANY DEFORMATION

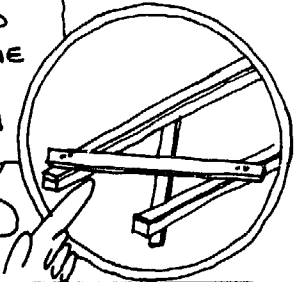

OPEN PANEL FOR DOOR

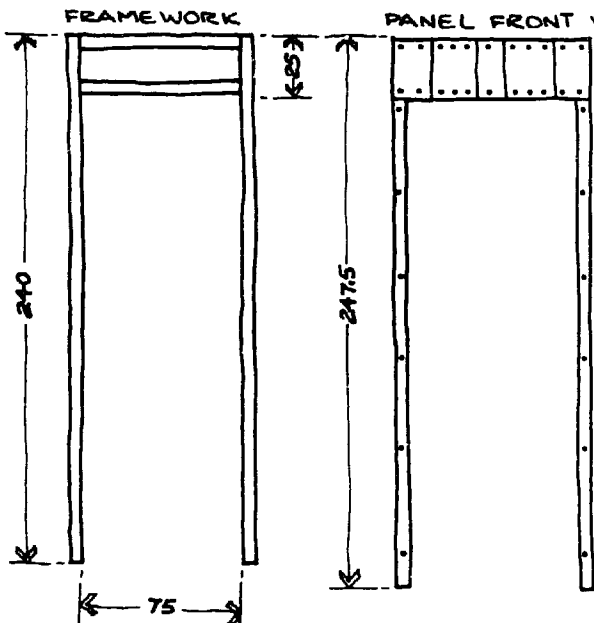

FRAMEWORK

PANEL FRONT VIEW

LIST OF MATERIALS:

FRAME

02	5x5x240 cm	TIMBER
02	5x5x75 cm	TIMBER
08	l=6,25 cm	NAILS
04	l=10 cm	NAILS

COVERING

04	1,25x5x12,5 cm	TIMBER
02	1,25x5x222,5 cm	TIMBER
05	1,25x20x25 cm	TIMBER
34	l=5 cm	NAILS

TO ASSEMBLE THE PANEL YOU MUST ASSEMBLE THE FRAME FIRST. TO MINIMIZE WASTAGE YOU SHOULD CUT THE TIMBER USED FOR THE FRAME AS SHOWN.

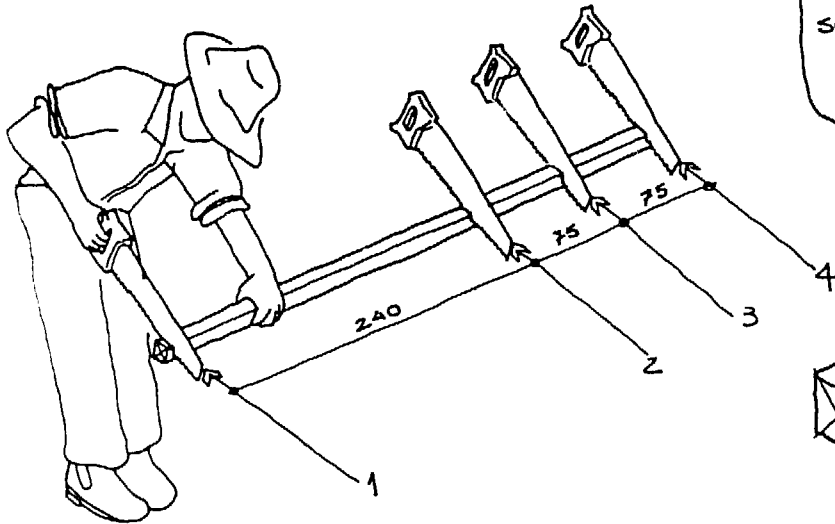

A DEVICE LIKE THIS ONE CAN BE USED TO CUT TIMBER SQUARE

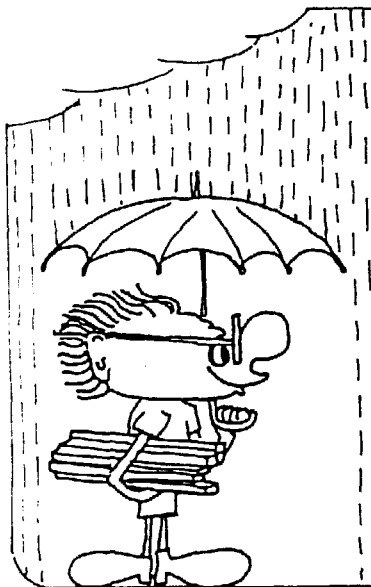
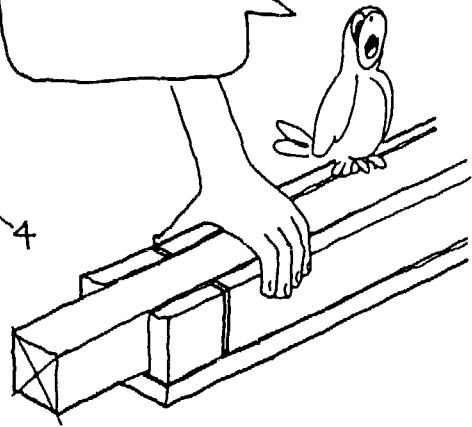

THE PIECES OF CUT TIMBER MUST BE PILED UP HORIZONTALLY IN A DRY PLACE.

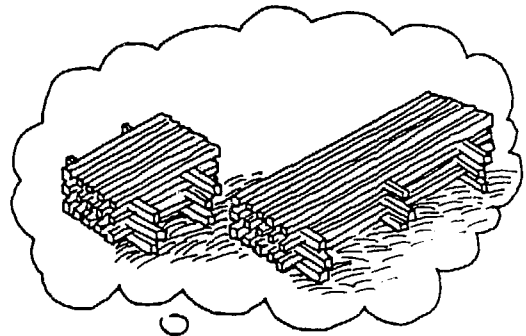

NOW YOU CAN BEGIN TO NAIL THE CROSSMEMBERS AT THE ENDS! TAKE CARE THAT THE FRAME IS SQUARE.

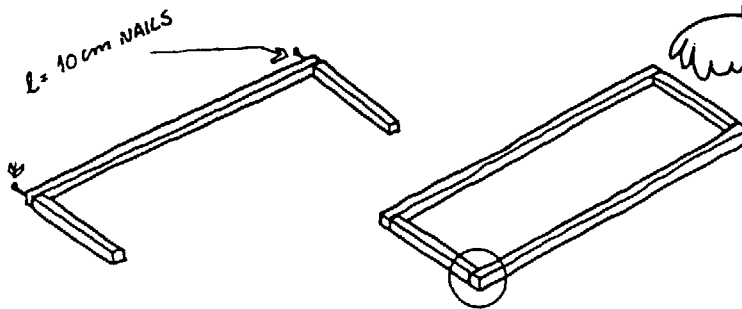

BEFORE NAILING YOU MUST DRILL THE TIMBER.

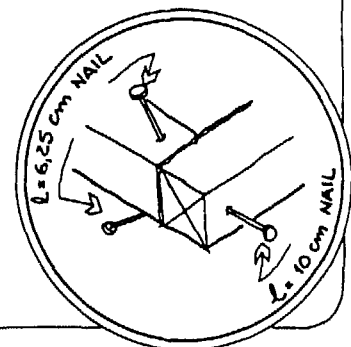

THE PANEL FRAME IS COVERED WITH BOARDS.
USE 250 cm LENGTH BOARDS.

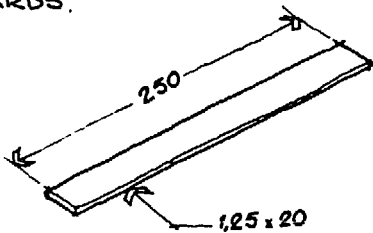

IMPORTANT!
NEVER START THE NEXT STAGE BEFORE CHECKING THAT THE FRAME IS "SQUARE"

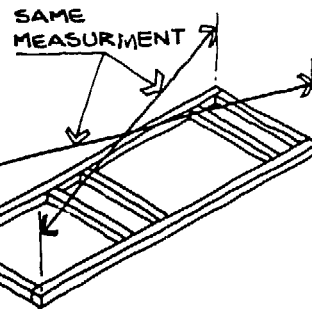

WHEN YOU BUY THE BOARDS, CHOOSE:

- DRY BOARDS;
- BOARDS OF THE SAME WIDTH AND THICKNESS.

YOU MUST AVOID:

- BOARDS WITH LOOSENED KNOTS;
- BOARDS WITH SPLITS;
- BOARDS WITH ROTTING SPOTS;
- WARPED BOARDS.

THE NEXT STEP IS THE COVERING OF THE PANELS.

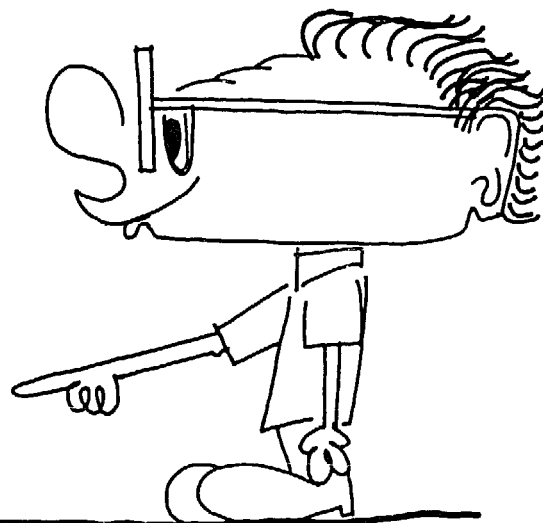

IMPORTANT!
KEEP ALL THE PIECES IN A DRY PLACE.

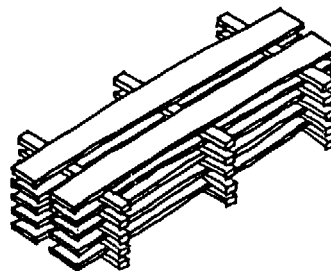
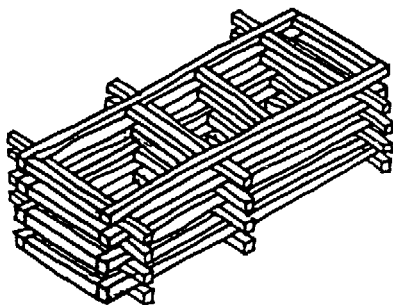

NOW, ATTENTION!
THE PANELS MUST BE MADE
CAREFULLY BECAUSE
THE QUALITY OF THE HOUSE
WILL DEPEND ON THEM.

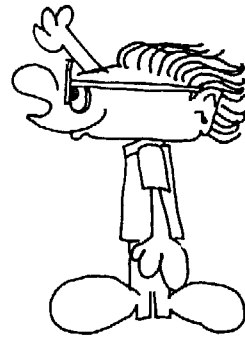

LET US GIVE
YOU SOME
ADVICE ON
NAILING THE
BOARDS.

FIRST YOU NAIL TWO BOARDS AT
THE EDGES OF THE FRAME. THE
FACED SURFACES OF THE BOARDS ARE
ON THE TOP. LEAVE SOME BOARD OVER
LAPING THE FRAME AT THE BOTTOM.

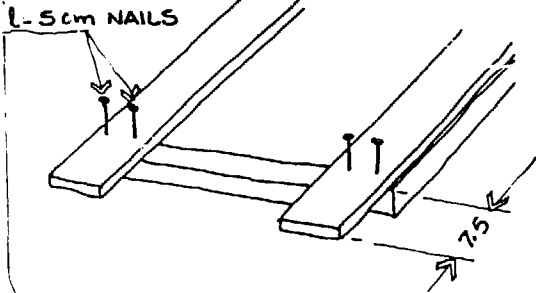

THEN NAIL THE MIDDLE BOARD.

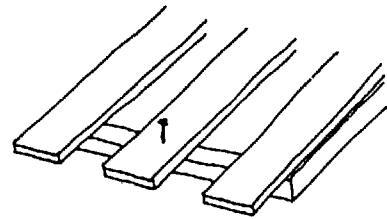

BEFORE NAILING THE UPPER
BOARDS, NAIL SPACERS CUT
FROM 1,25 x 5 cm TIMBER STRIPS.

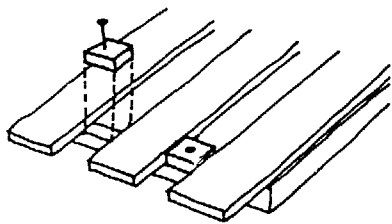

NEXT, YOU ONLY HAVE TO NAIL THE
UPPER BOARDS, BEING CAREFULL
NOT TO HAMMER A NAIL INTO THE
SPACE BETWEEN THE BOARDS.

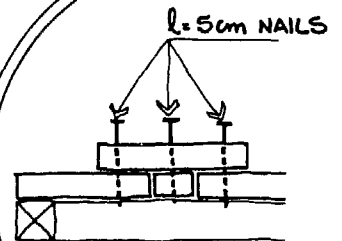
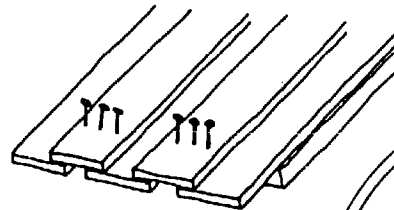

AFTER THE PANELS ARE
READY, STACK THEM UP
TO A MAXIMUM OF 12
HIGH IN A PROTECTED
PLACE

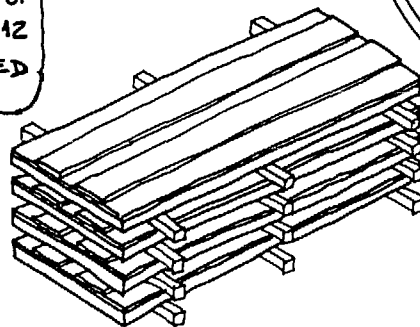
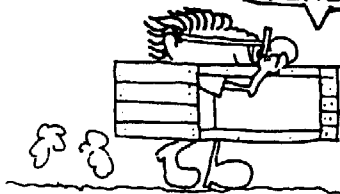

HOW TO MAKE THE INTER-PANEL STUDS

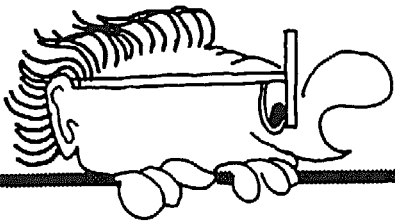

THE INTER-PANEL STUDS ARE CUT BEFORE BEING TAKEN TO THE WORK SITE, BUT THE NAILING IS DONE ON LOCATION.

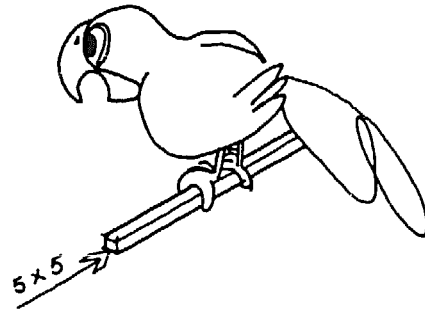

THE INTER-PANEL STUDS ARE CUT IN DIFFERENT LENGTHS, ACCORDING TO THE PLACE THEY ARE INTENDED FOR.

THESE INTER-PANEL STUDS ARE CUT SHORTER IN ORDER TO SUPPORT THE PORCH BEAMS.

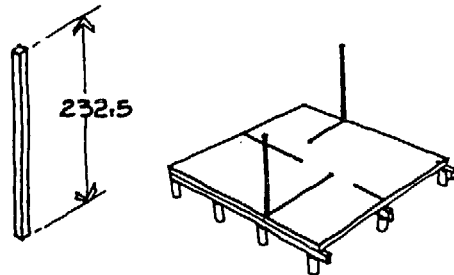

AND HERE ARE THE INTER-PANEL STUDS

THESE INTER-PANEL STUDS ARE CUT LONGER IN ORDER TO PERMIT THE ASSEMBLY OF THE RIDGE BEAM.

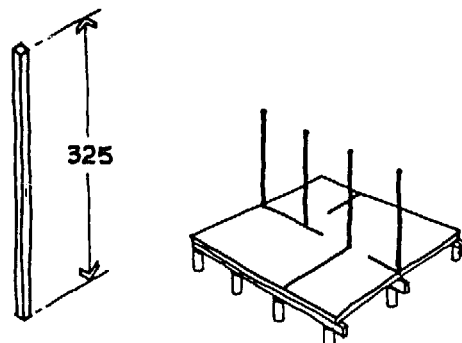
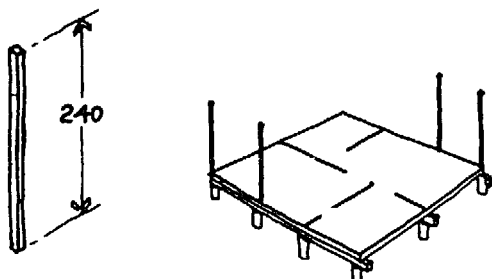

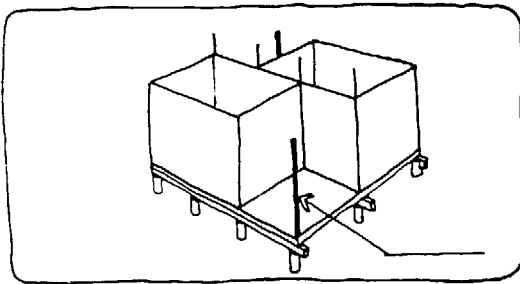

HOW TO MAKE THE PORCH SUPPORT POST

THIS POST IS MADE FROM TWO PIECES OF TIMBER OF DIFFERENT SIZES AND FOUR L. 10cm NAILS

THE PIECES ARE NAILED ON BOTH SIDES

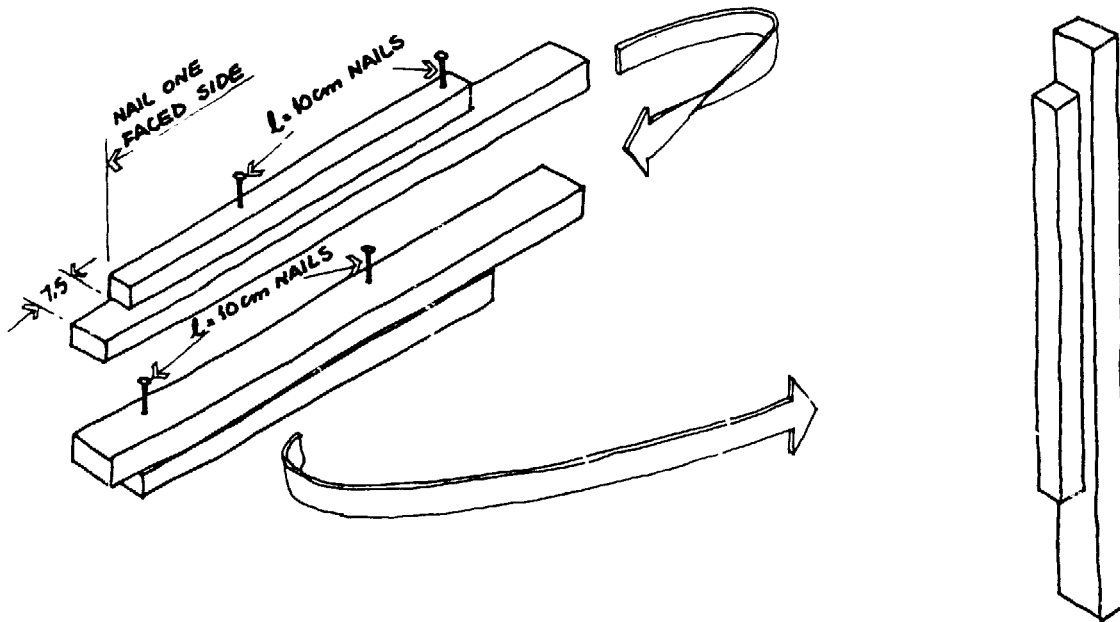
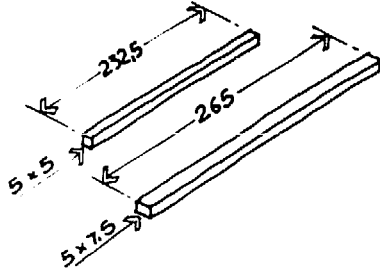

HOW TO MAKE THE PORCH BEAM

THE PORCH BEAM IS CUT BEFORE HAND, BUT NAILED AT THE WORK SITE.

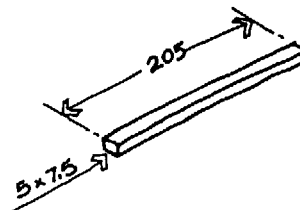
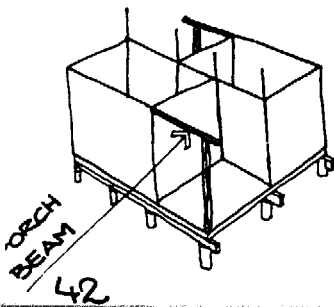

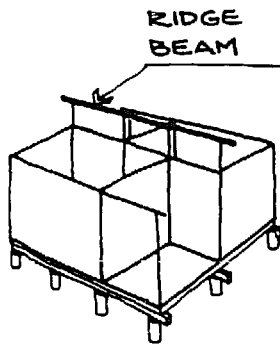

HOW TO MAKE THE RIDGE BEAM

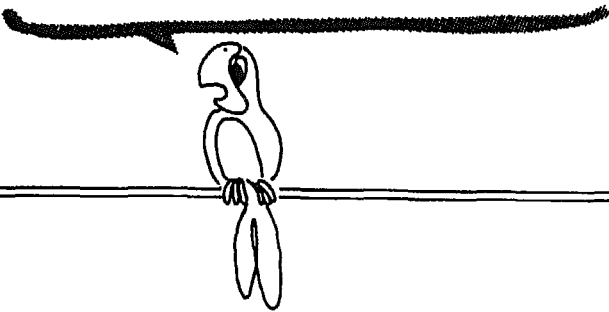

THE RIDGE BEAM IS ALSO CUT BEFORE BEING SENT TO THE WORK SITE, BUT THE NAILING IS DONE ON SITE.

THE RIDGE BEAM IS COMPOSED OF TWO DIFFERENT PARTS: A MIDDLE RIDGE BEAM AND AN END RIDGE BEAM.

THE MIDDLE RIDGE BEAM IS MADE THIS WAY ...

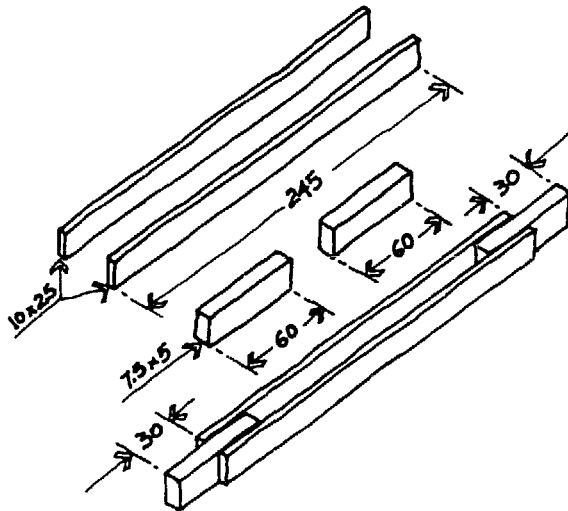

... AND THE END RIDGE BEAM IS MADE THIS WAY ...

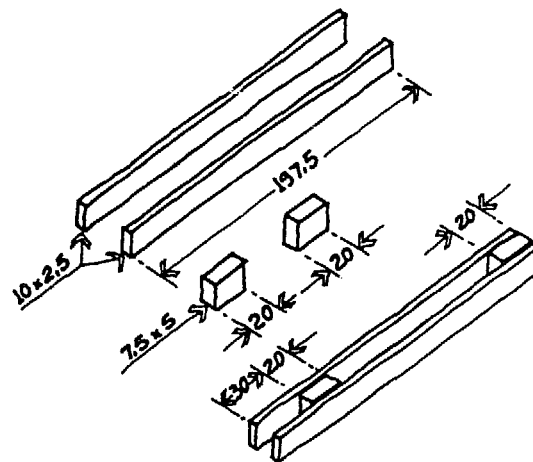

IF YOUR HOUSE IS LARGER THAN THE A TYPE HOUSE, YOU WILL NEED AN EXTENSION RIDGE BEAM. IT IS MADE THIS WAY ...

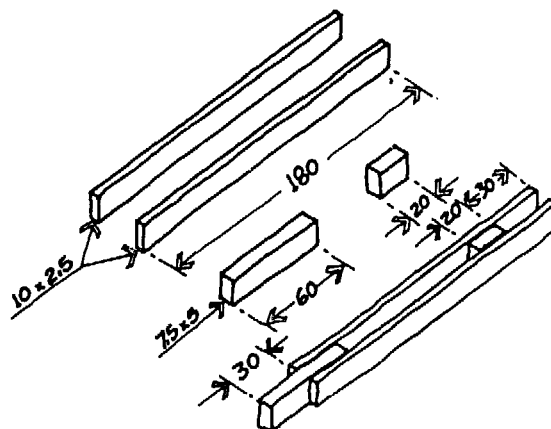

YOU MAKE THE RIDGE BEAM BY JOINING THE MIDDLE AND END RIDGE BEAMS.

IF YOU ARE GOING TO MAKE THE RIDGE BEAM FOR A TYPE HOUSE YOU MUST JOIN TWO END BEAMS AND ONE MIDDLE BEAM.

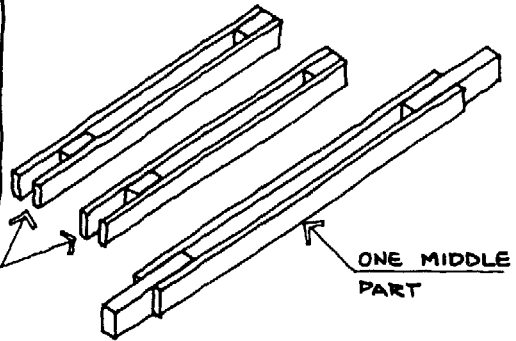
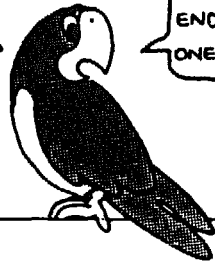

TWO END PARTS

ONE MIDDLE PART

TO JOIN THE PARTS YOU FIT THE TONGUE OF THE MIDDLE PART INTO THE GROOVE OF THE END PART AND NAIL THE TWO TOGETHER.

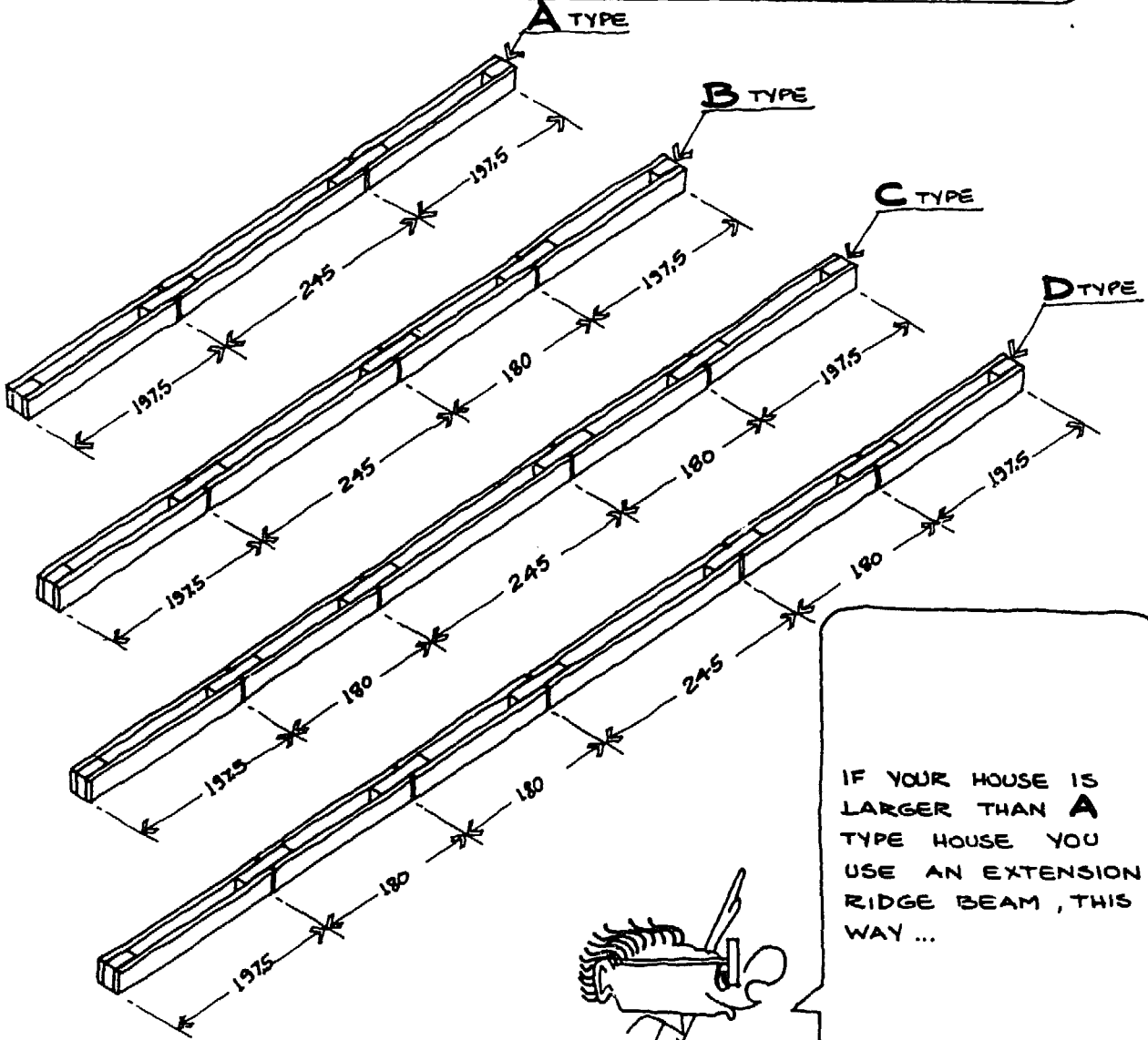
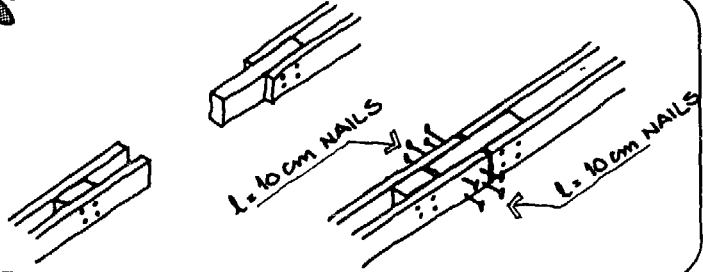

IF YOUR HOUSE IS LARGER THAN A TYPE HOUSE YOU USE AN EXTENSION RIDGE BEAM, THIS WAY ...

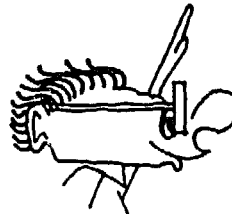

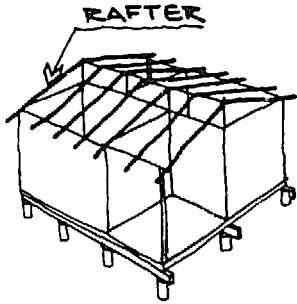

HOW TO MAKE THE RAFTERS



EACH RAFTER IS MADE THIS WAY ...

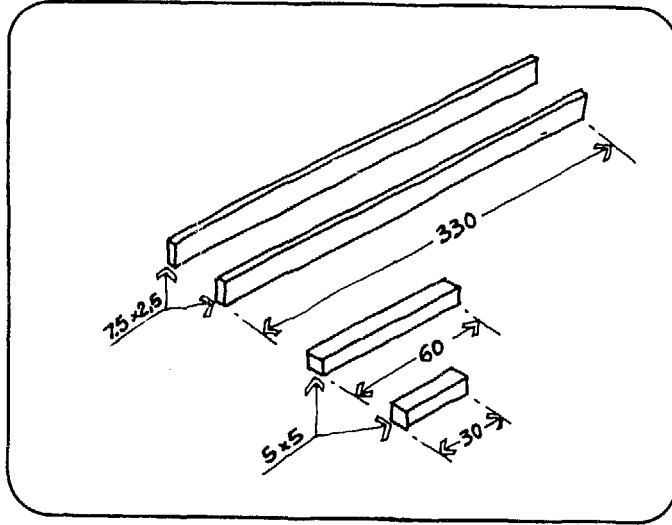

IT MUST BE NAILED ON BOTH SIDES

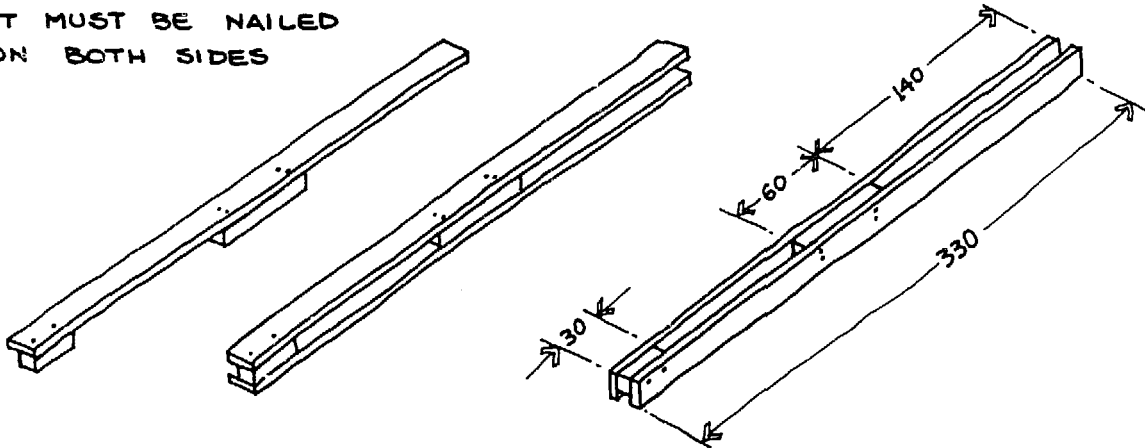

YOU MUST BE CAREFUL NOT TO DRIVE THE NAILS IN EXACTLY OPPOSITE EACH OTHER

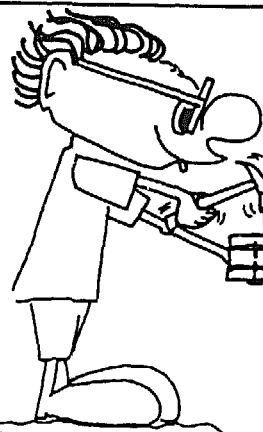

RIGHT POSITION
WRONG POSITION



OOOPS! I HAVE TO GO NOW.
BUT I'M GOING TO LEAVE YOU WITH
POLLY WHO IS GOING TO EXPLAIN
IN SIMPLE LANGUAGE HOW YOU BUILD
THE HOUSE WITH ALL THE PIECES
YOU HAVE MADE . KEEP ON READING
AND PAY ATTENTION TO WHAT
POLLY IS GOING TO TELL YOU.
BYE , BYE !

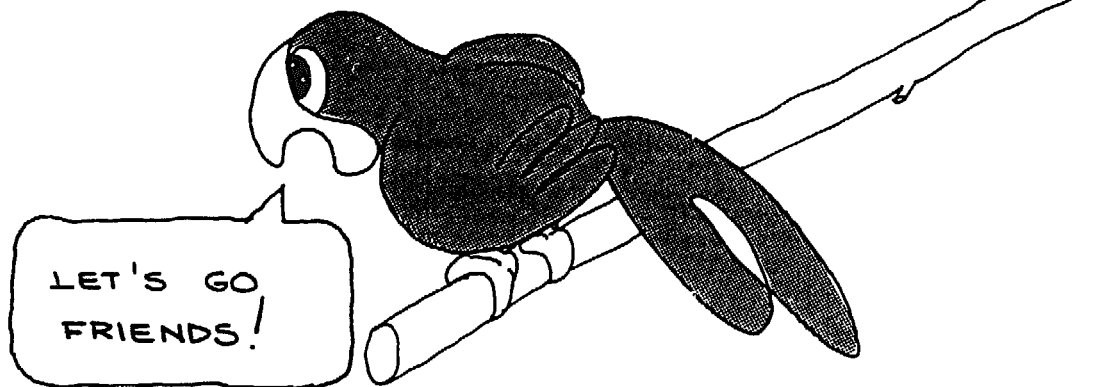
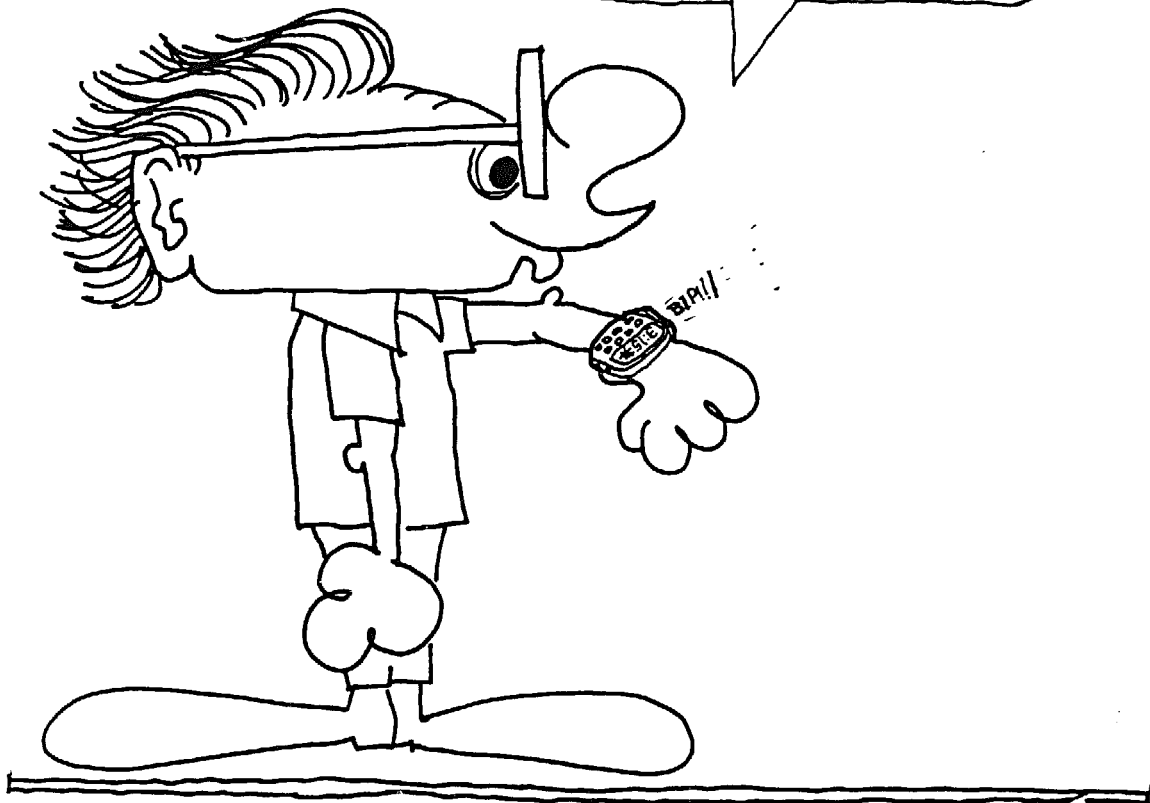

LET'S GO
FRIENDS!

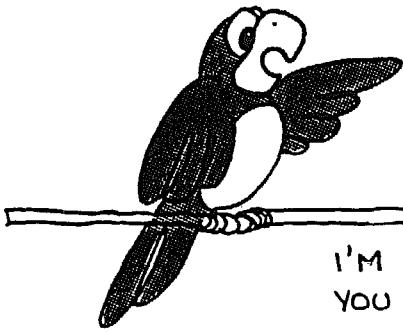

HOW TO BUILD YOUR HOUSE

I'M NOW GOING TO EXPLAIN EVERYTHING YOU MUST DO TO ASSEMBLE THE HOUSE.

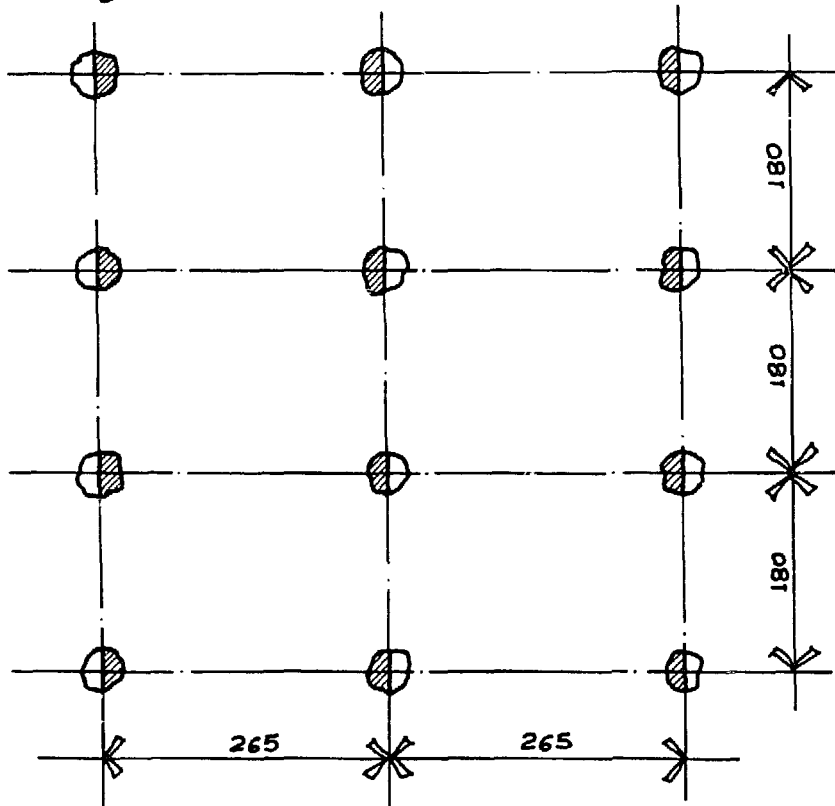

GROUND PLAN

TO BEGIN WITH, EXAMINE THE SKETCH ON THE LEFT. IT SHOWS THE POSITIONS OF THE PILES AND HOW THEY WILL LOOK AFTER THEY ARE INSTALLED AND HAVE SLOTS CUT IN THEM.

IT SHOWS THE POSITIONS OF THE PILES AND HOW THEY WILL LOOK AFTER THEY ARE INSTALLED AND HAVE SLOTS CUT IN THEM.

* BE SURE TO USE ONLY PILES WITH HEARTWOOD OF DURABLE TIMBER!

YOU MUST LEAVE AT LEAST HALF THE THICKNESS OF PILE.

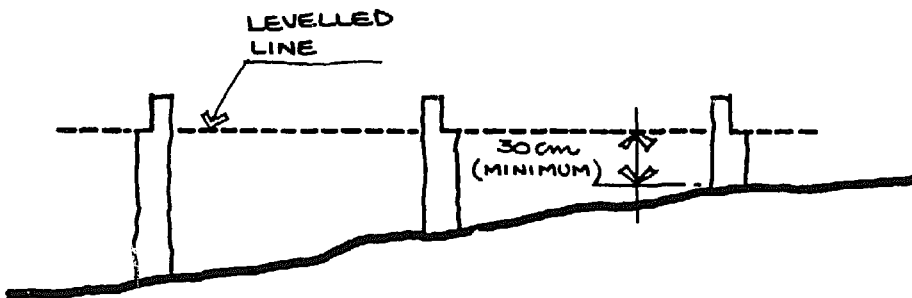

CROSS SECTION

IMPORTANT

YOU MUST CUT A SLOT IN EACH PILE, MAKING SURE THAT ALL THE HORIZONTAL CUTS ARE AT THE SAME LEVEL AND THAT THE VERTICAL CUTS ARE PROPERLY ALIGNED. WHEN MAKING THE SLOT LEAVE AT LEAST HALF THE THICKNESS OF THE POLE.

LET'S BEGIN WITH THE PREPARATION OF THE BUILDING SITE

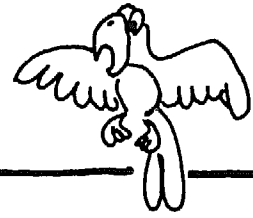

FIRST, YOU MUST MARK ON THE PLOT THE PLACE WHERE THE HOUSE IS GOING TO BE BUILT. YOU MUST REMEMBER THAT, AFTERWARDS, YOU WILL ONLY BE ABLE TO ENLARGE YOUR HOUSE FRONTWARDS.

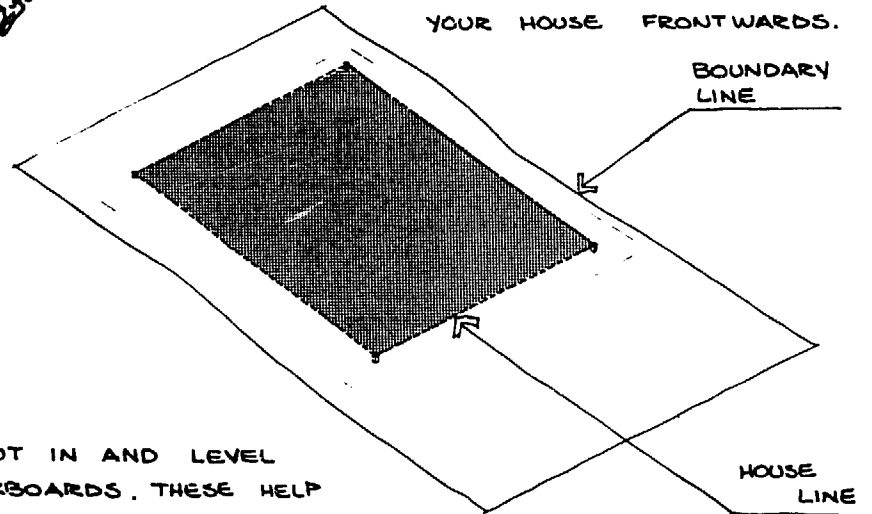

YOU MUST PUT IN AND LEVEL THE BATTERBOARDS. THESE HELP YOU LOCATE EXACTLY THE POSITIONS OF THE PILES.

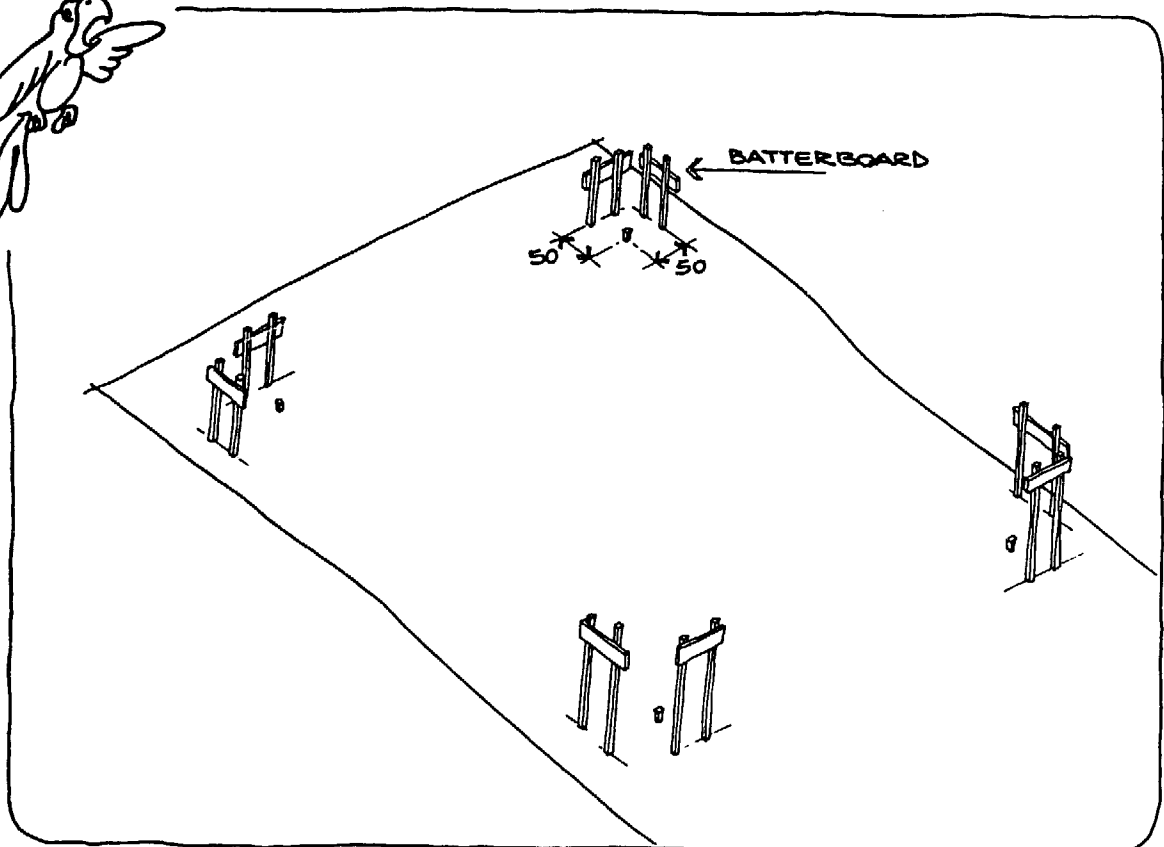

LEVELLING AND FIXING BATTERBOARDS

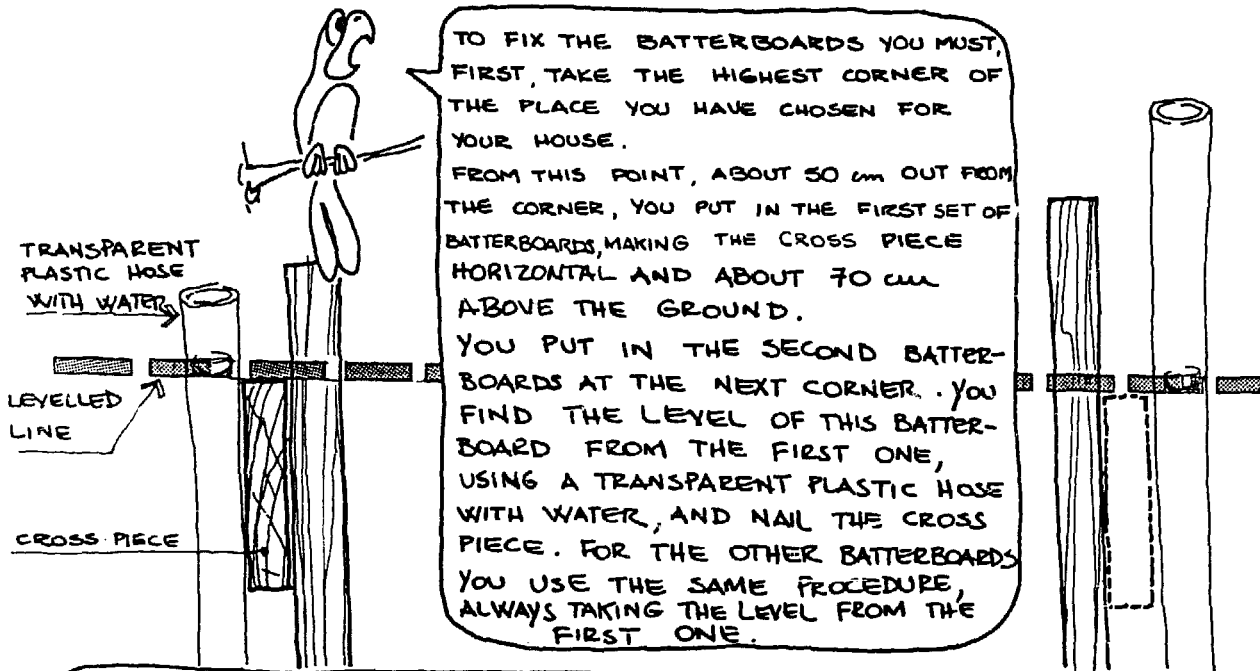
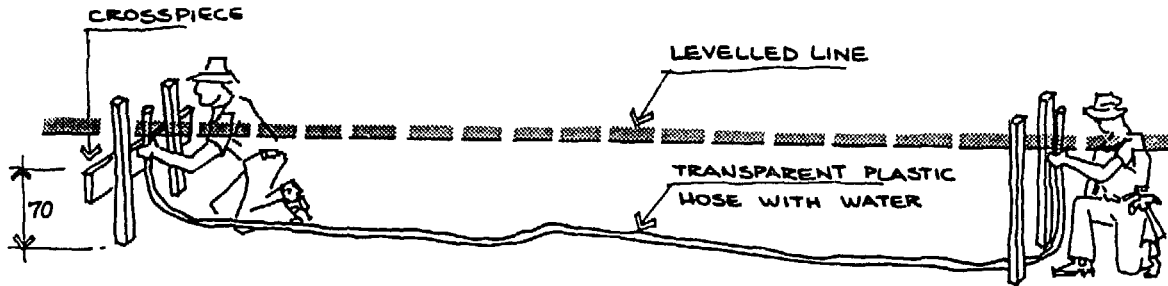

TO FIX THE BATTERBOARDS YOU MUST, FIRST, TAKE THE HIGHEST CORNER OF THE PLACE YOU HAVE CHOSEN FOR YOUR HOUSE. FROM THIS POINT, ABOUT 50 cm OUT FROM THE CORNER, YOU PUT IN THE FIRST SET OF BATTERBOARDS, MAKING THE CROSS PIECE HORIZONTAL AND ABOUT 70 cm ABOVE THE GROUND. YOU PUT IN THE SECOND BATTERBOARDS AT THE NEXT CORNER. YOU FIND THE LEVEL OF THIS BATTERBOARD FROM THE FIRST ONE, USING A TRANSPARENT PLASTIC HOSE WITH WATER, AND NAIL THE CROSS PIECE. FOR THE OTHER BATTERBOARDS YOU USE THE SAME PROCEDURE, ALWAYS TAKING THE LEVEL FROM THE FIRST ONE.

YOU NOW STRETCH STRINGS BETWEEN THE BATTERBOARDS SQUARING THE CORNERS OF MAIN LINES, THIS WAY...

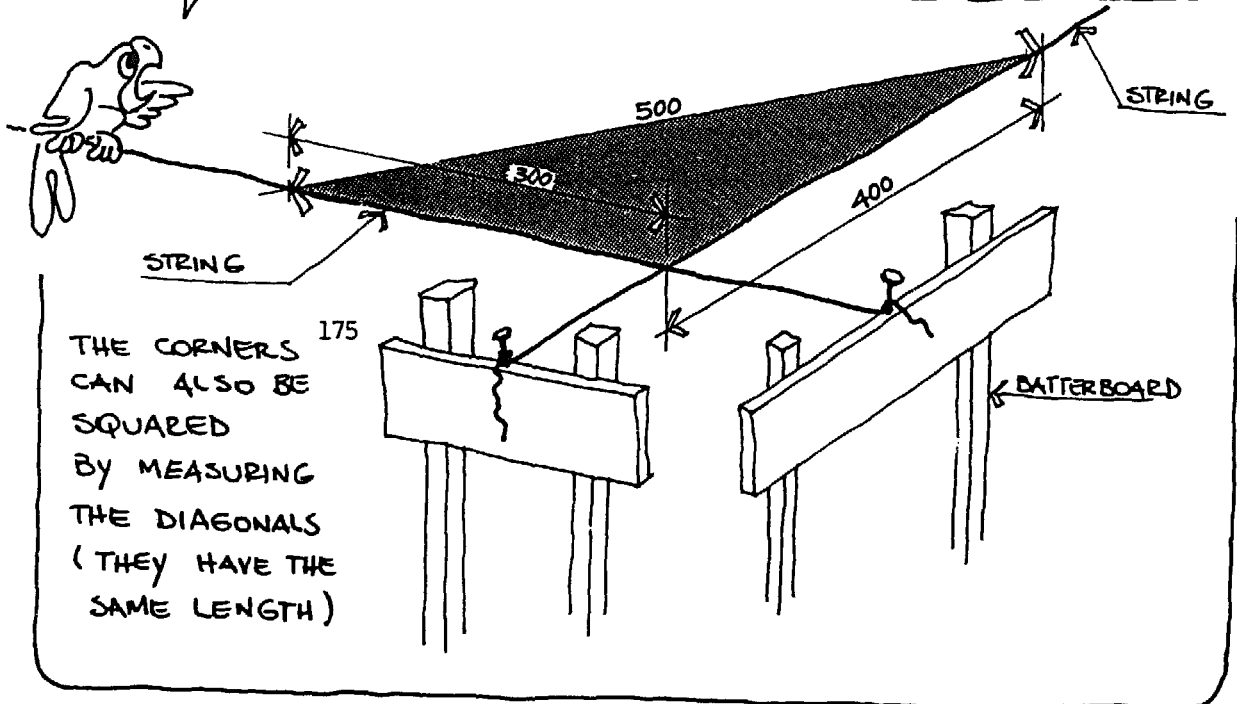

THE CORNERS CAN ALSO BE SQUARED BY MEASURING THE DIAGONALS (THEY HAVE THE SAME LENGTH)

STAKING AND LAYING OUT THE HOUSE ...

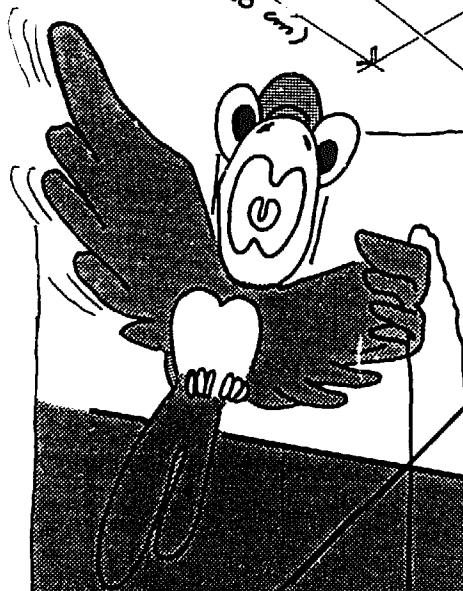
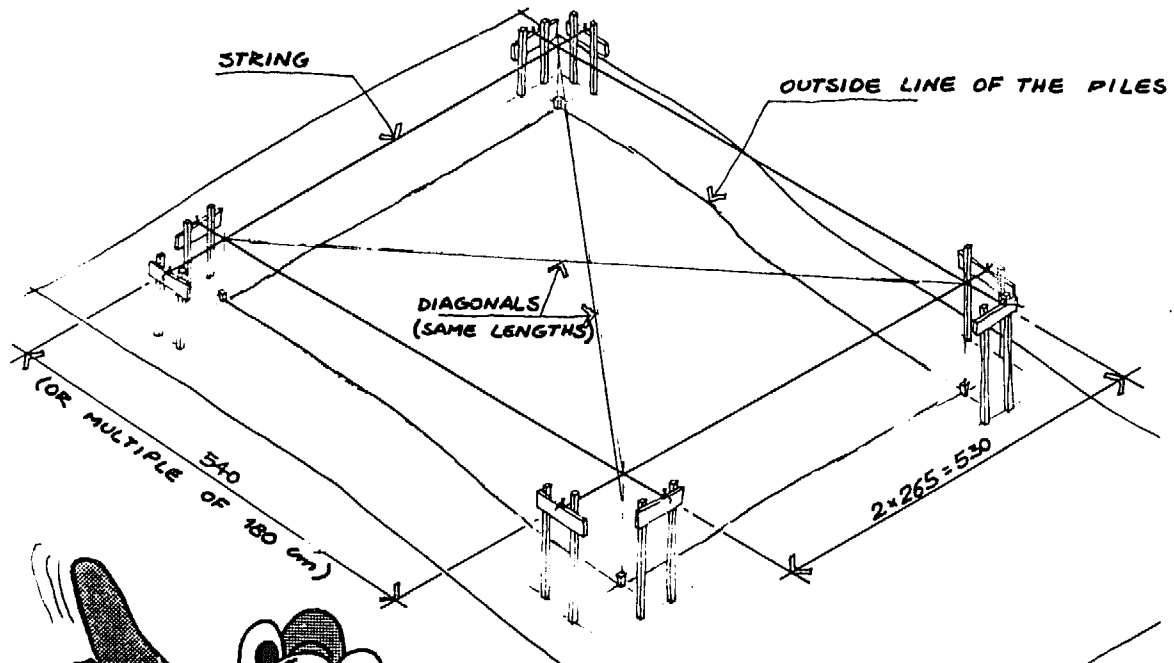

YOU FIRST STAKE THE HOUSE CORNERS ... AND NEXT, WITH A FOLDING RULE OR A MEASURING TAPE AND A PLUMB BOB, YOU MARK THE OTHER INTERMEDIATE POINTS

SQUARED TAUT LINES

ALWAYS MEASURE FROM THE CORNERS AND MEASURE ON THE STRINGS.

ONCE ALL THE PILE POSITIONS ARE MARKED WITH STAKES YOU CAREFULLY REMOVE THE STRINGS.

YOU NOW DIG THE HOLES FOR THE PILES.

PREPARING PILE HOLES ...

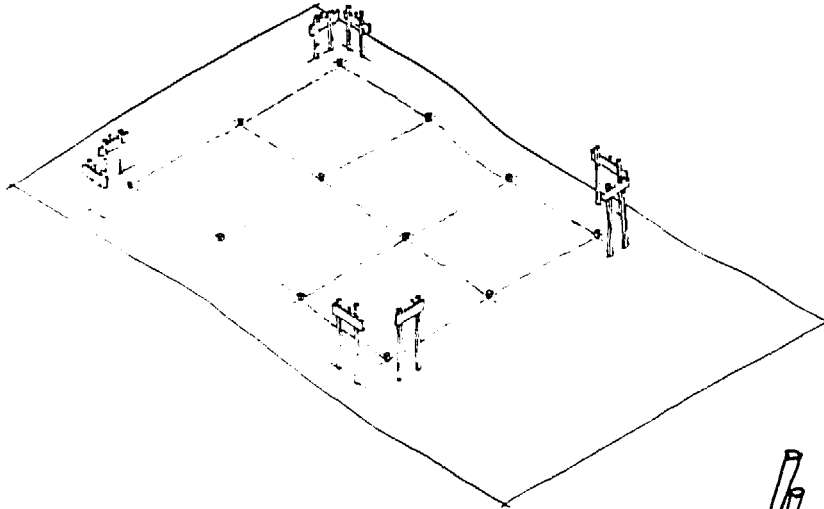
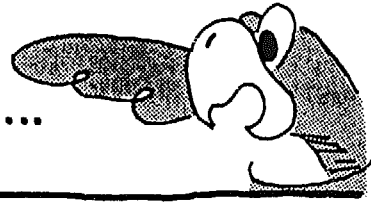

IMPORTANT.
REMOVE ONLY THE
STRINGS.
YOU ARE GOING TO
USE BATTERBOARDS
AGAIN TO POSITION
THE PILES, MARK
THE SLOTS AND
ALIGN THE BEAMS.

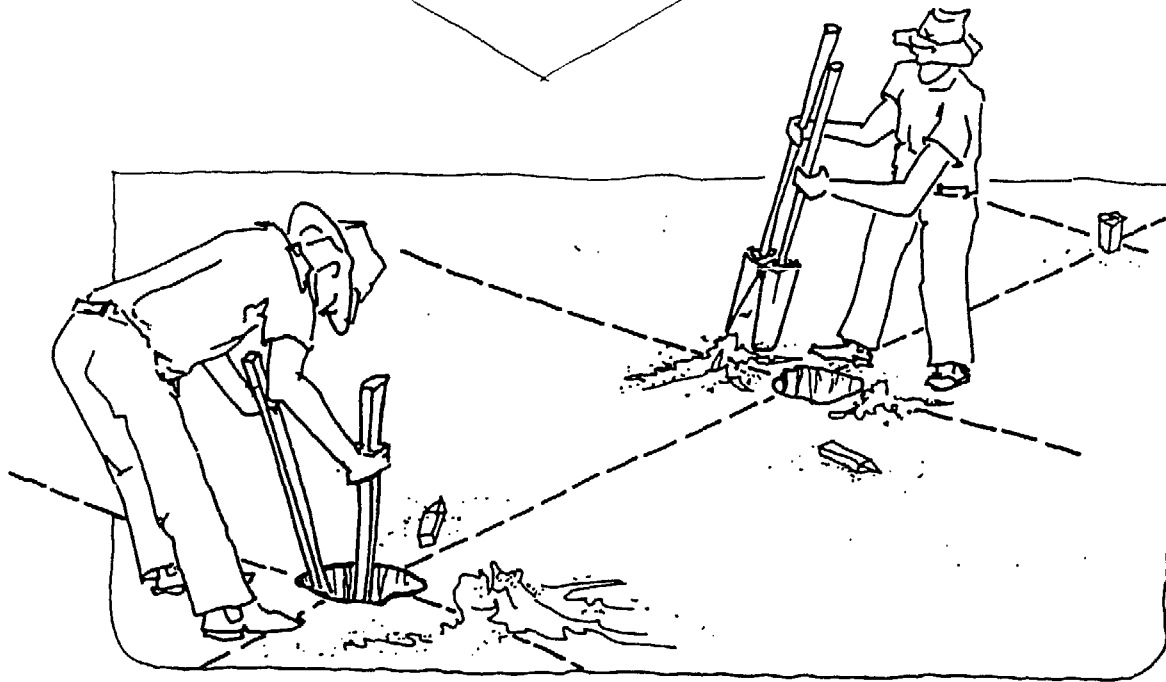

PILE DIAMETER 15-20 cm

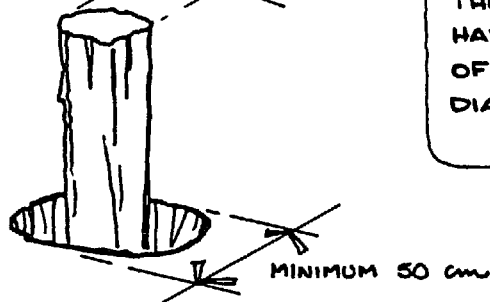

THE HOLES MUST
HAVE A MINIMUM
OF 50 cm OF
DIAMETER.

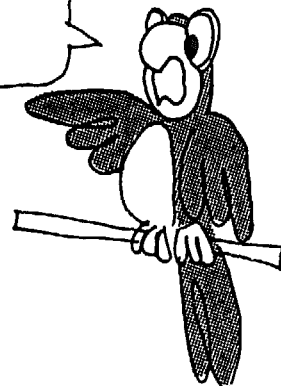

THE DEPTH OF THE HOLES MUST BE EQUAL TO OR LARGER THAN THE PILE THAT STAYS ABOVE GROUND (MIN. 70cm)

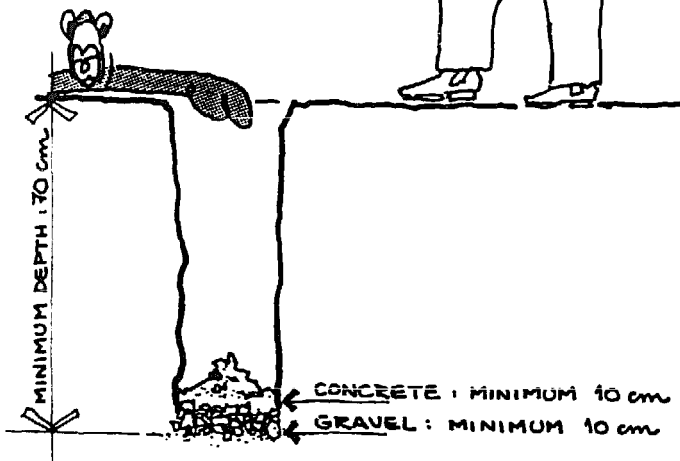
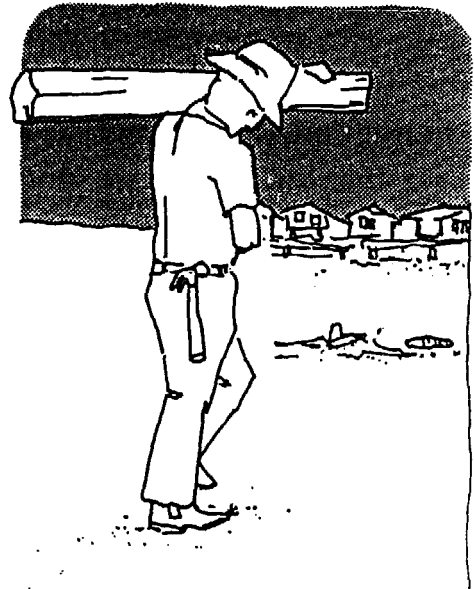
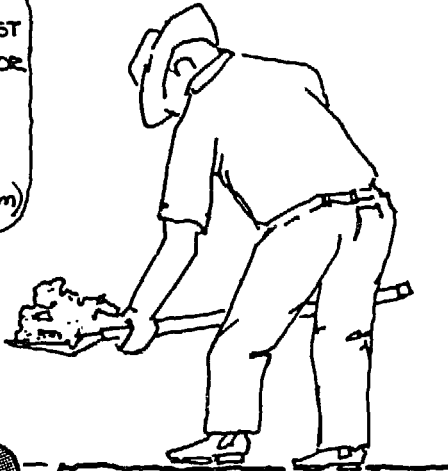

PREPARE THE BOTTOM OF THE HOLE. FIRST THROW IN GRAVEL (10 cm) AND WEAK CONCRETE (10 cm). AFTER DOING THIS YOU PACK THE BOTTOM OF THE HOLE BY POUNDING WITH THE PILE ITSELF.

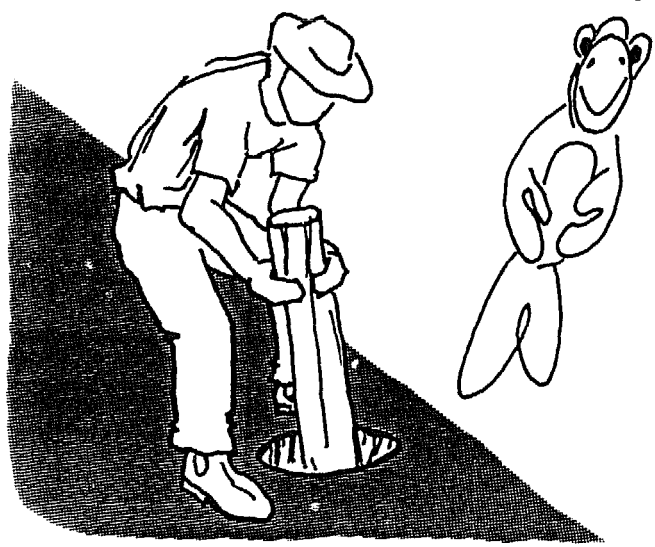

THE PILES ARE ALIGNED BY STRETCHING THE STRINGS AGAIN.

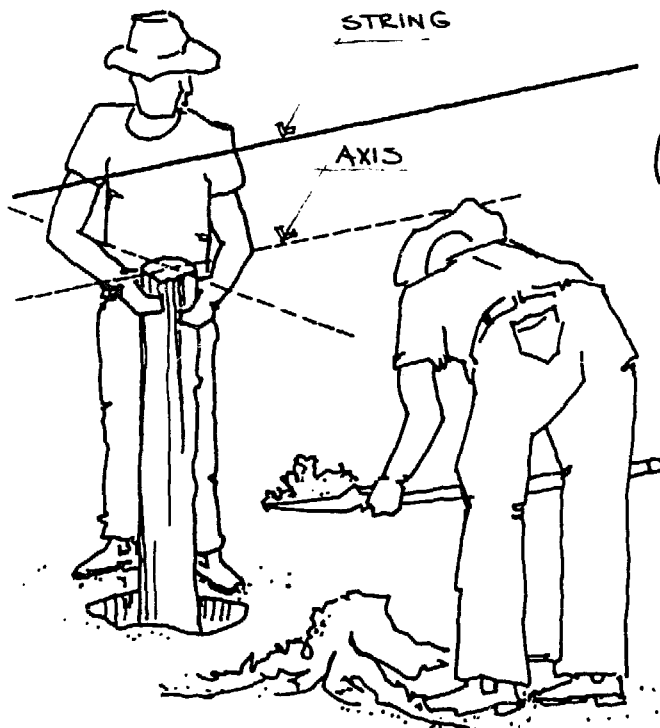
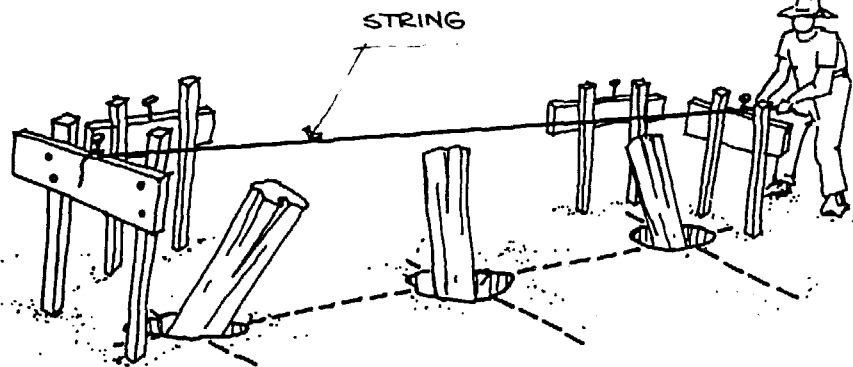

AFTER CHECKING THE ALIGNMENT AND PLUMB, YOU FIX THE PILES BY FILLING THE HOLES WITH A SOIL CEMENT MADE BY MIXING THE EARTH REMOVED FROM THE HOLES WITH CEMENT IN A 1:10 RATIO, WETTING AND STAMPING THE MIXTURE INTO THE HOLE.

THE FREE END OF THE PILE :

THE PILE IS PREPARED FOR USE BY MAKING:

1. VERTICAL CUTS, ALIGNED AND PLUMBED (MADE VERTICAL).
2. HORIZONTAL CUTS, LEVELLED,
3. BOTH CUTS SQUARED.

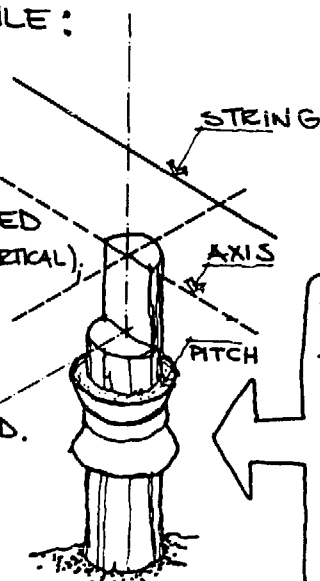

YOU MAY USE A METAL TERMITE SHIELD AS A BARRIER ON PILES TO PROTECT THE REST OF THE HOUSE. FOR BEST EFFECT FILL THE TOP FUNNEL WITH PITCH.

NOW THAT THE PILES ARE ALL ALIGNED, PLUMBED
AND LEVELLED, WE ARE GOING TO PLACE
THE **MAIN BEAMS** !

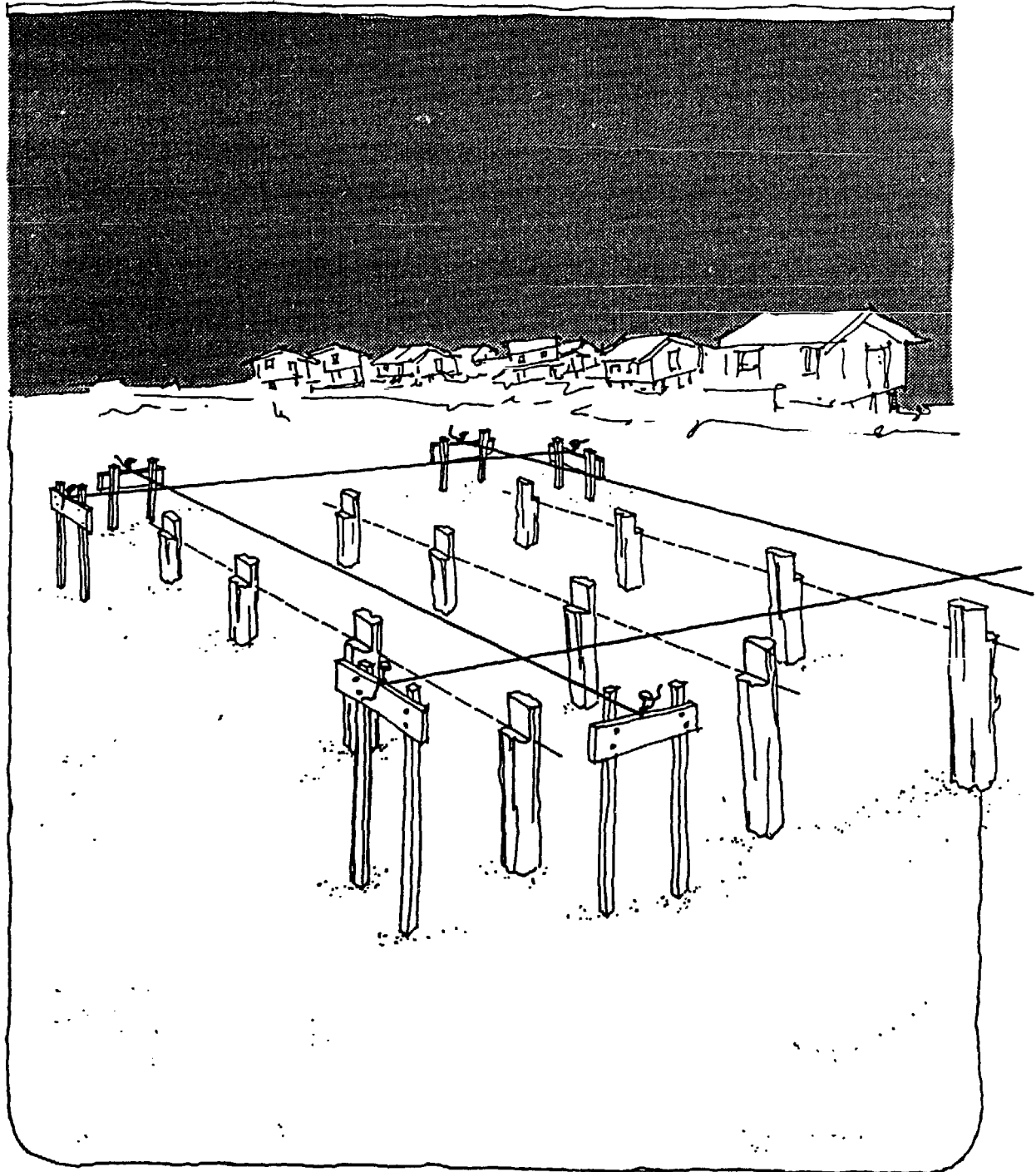

AFTER PLACING THE MAIN BEAM YOU CHECK THE LEVEL ...

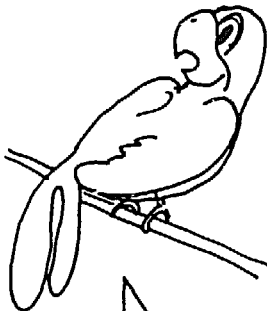
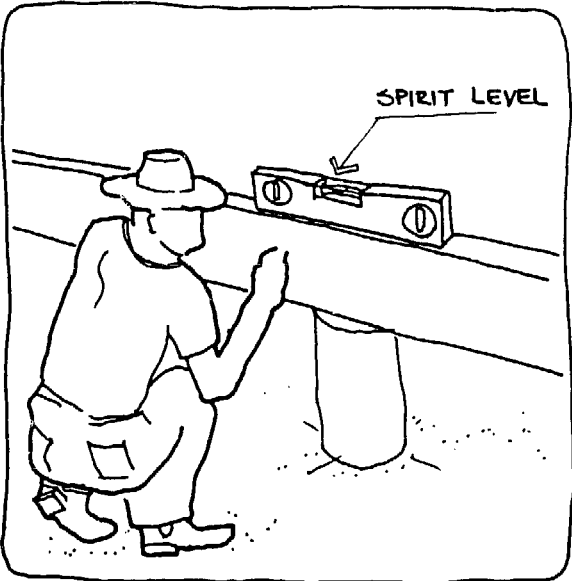

DON'T FORGET TO USE ONLY HEART-WOOD OF DURABLE TIMBER ON MAIN BEAMS.

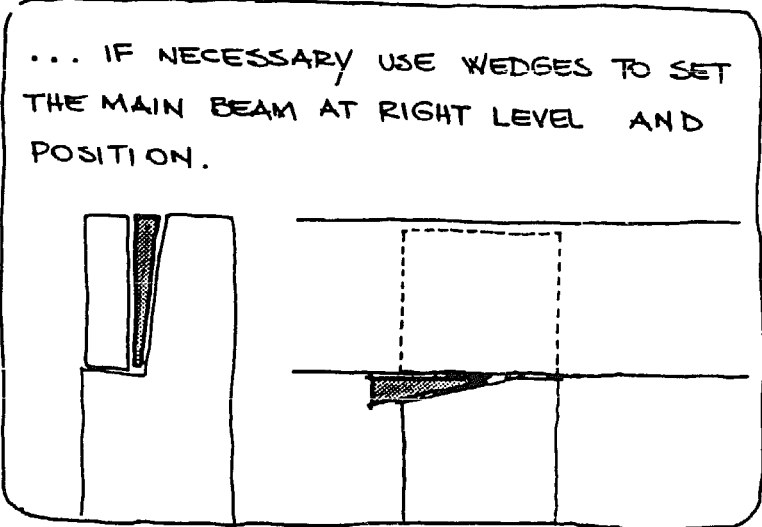

USE $l=10$ cm NAILS TO NAIL THE MAIN BEAM TO THE PILES (MINIMUM 4 NAILS).

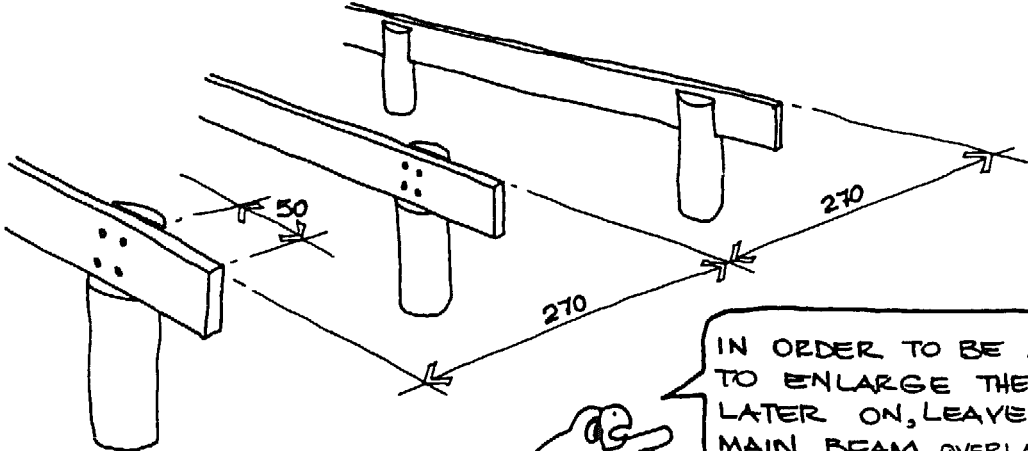

IN ORDER TO BE ABLE TO ENLARGE THE HOUSE LATER ON, LEAVE THE MAIN BEAM OVERLAPPING BY 50 cm BEYOND THE PILE.

THE MAIN BEAM PIECES ARE JOINED WITH A CLEAT (BLOCK OF WOOD)

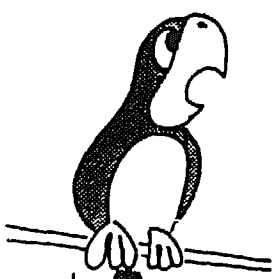

YOU ALSO USE THIS TYPE OF JOINT WHEN YOU ENLARGE THE HOUSE

... ON A SUPPORT

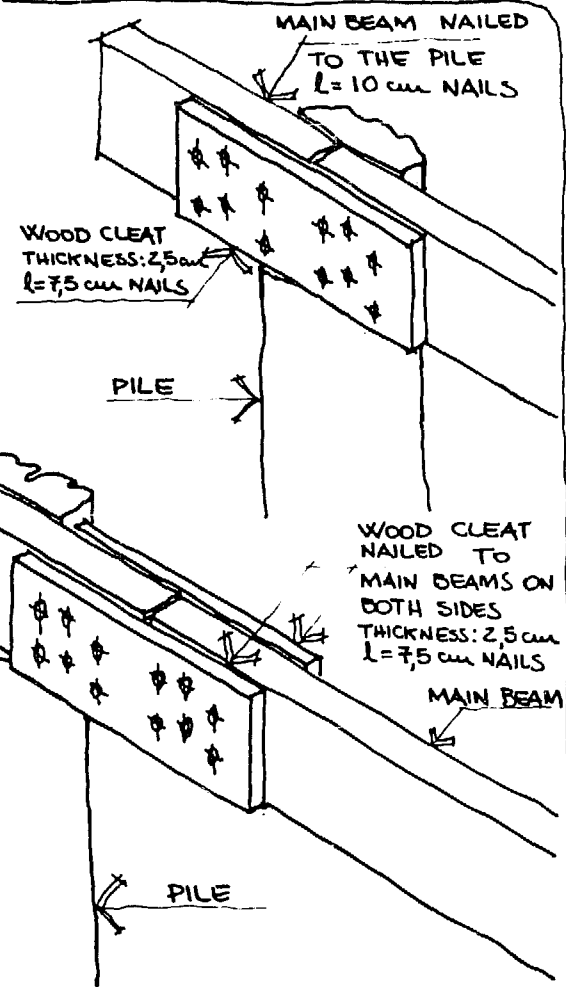

... NOT ON A SUPPORT

THE JOISTS ARE JOINED END TO END LIKE THIS...

WOOD CLEAT NAILED TO JOIST THICKNESS: 5 cm L=10 cm NAILS

JOIST (OVERLAP JOINT. THIS TYPE IS USED FOR JOISTS OFF THE LINE OF THE PILES)

JOIST (THIS TYPE OF JOINT IS USED ONLY FOR JOISTS ALIGNED WITH THE PILES)

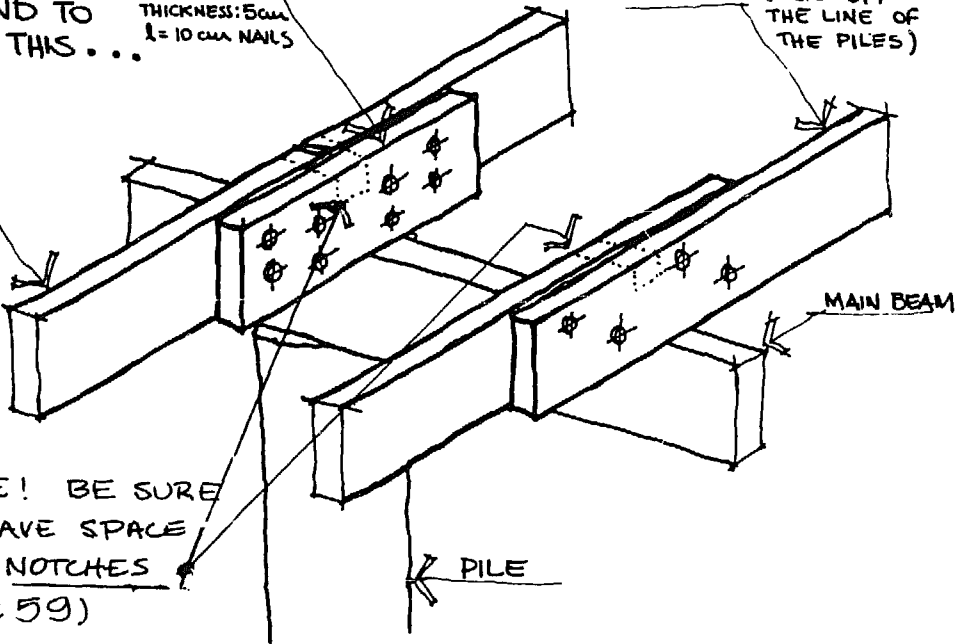

NOTE! BE SURE TO LEAVE SPACE FOR NOTCHES (PAGE 59)

THE NAILING OF THE JOISTS TO MAIN BEAMS IS DONE LIKE THIS...

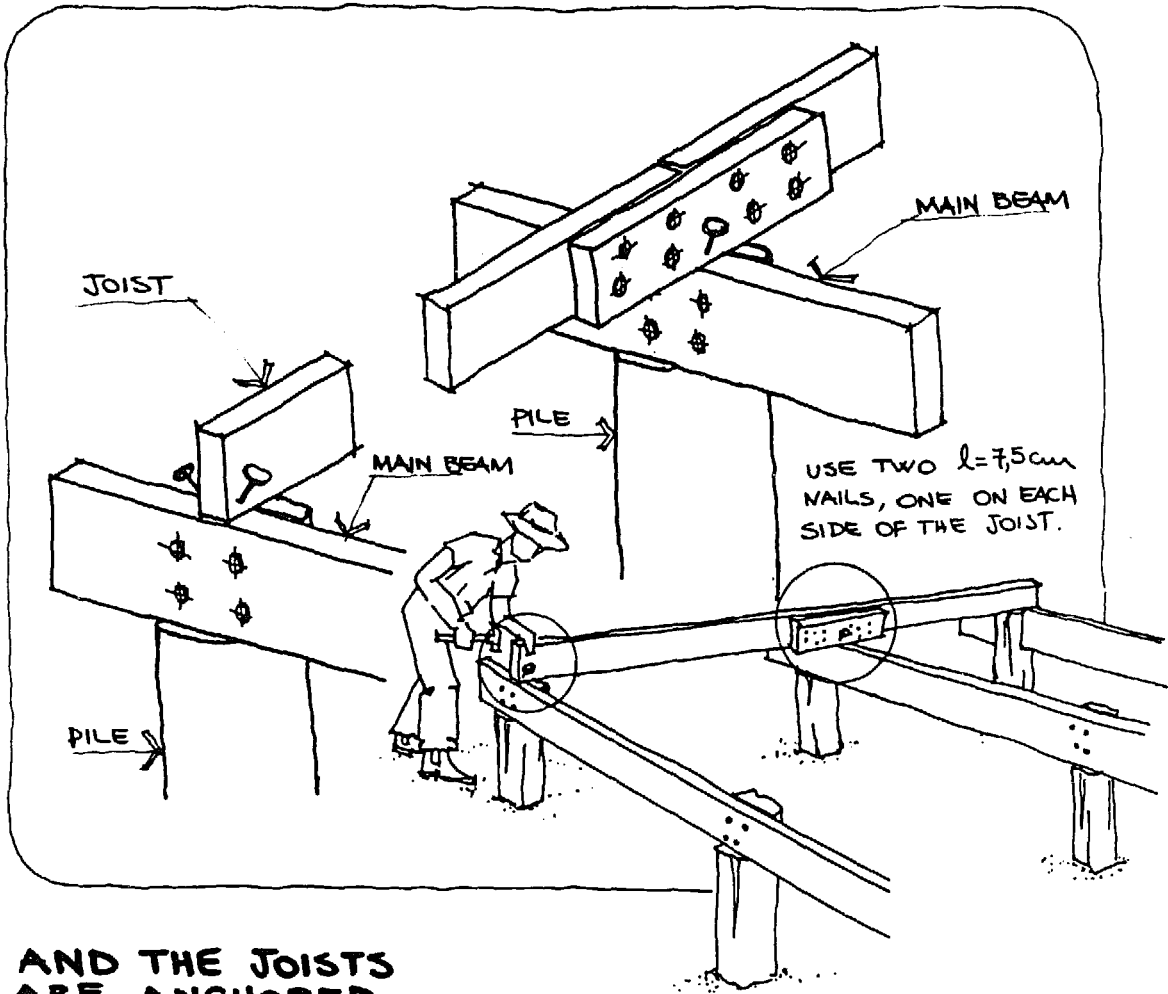

AND THE JOISTS ARE ANCHORED LIKE THIS...

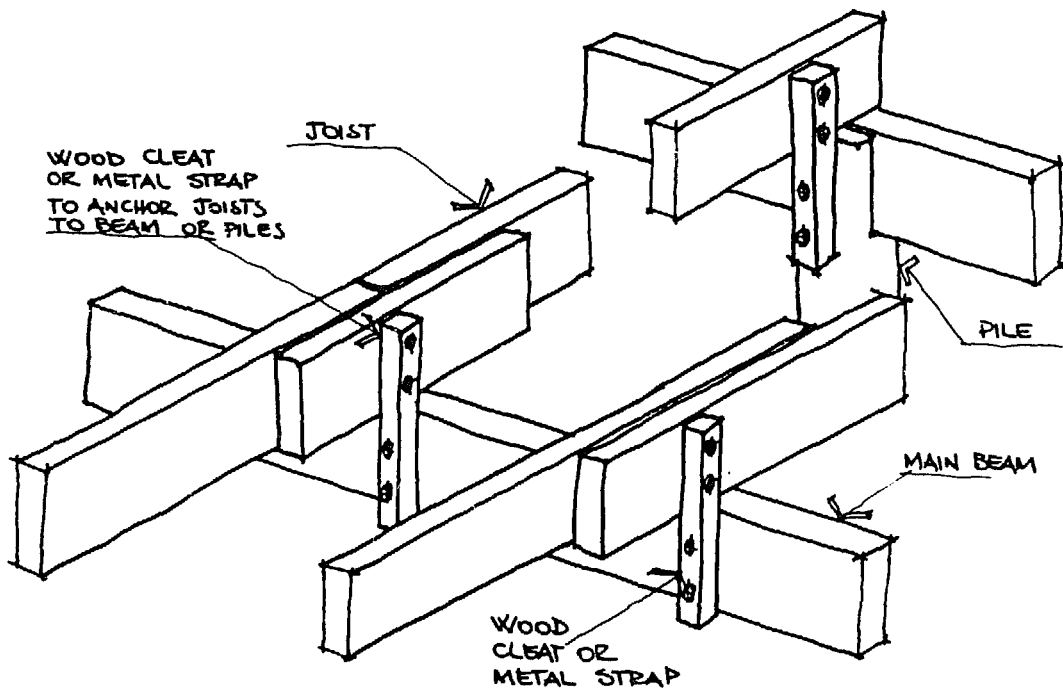

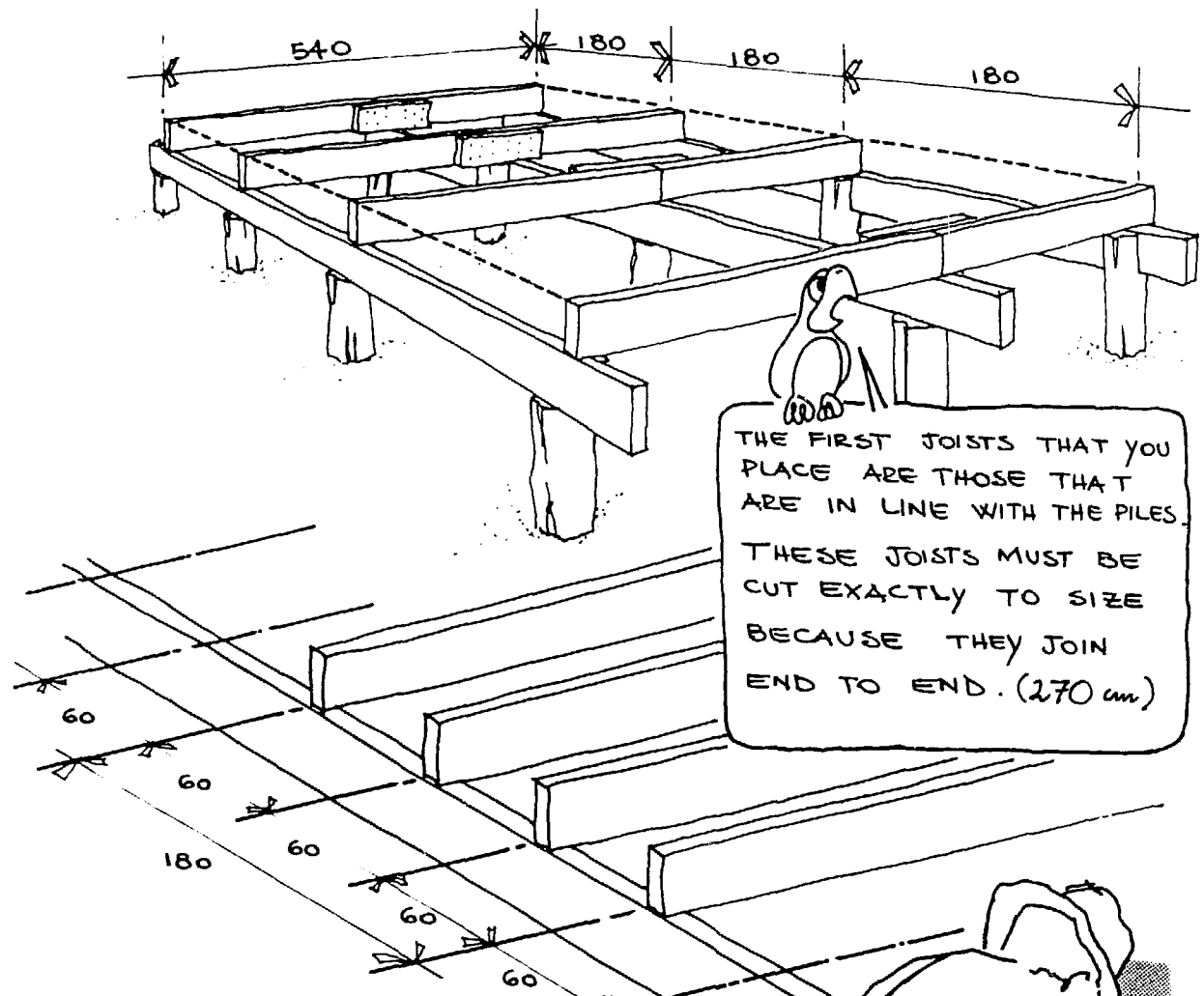

THE FIRST JOISTS THAT YOU PLACE ARE THOSE THAT ARE IN LINE WITH THE PILES. THESE JOISTS MUST BE CUT EXACTLY TO SIZE BECAUSE THEY JOIN END TO END. (270 cm)

... THEN YOU PLACE TWO INTERMEDIATE JOISTS BETWEEN THEM LIKE THIS ...

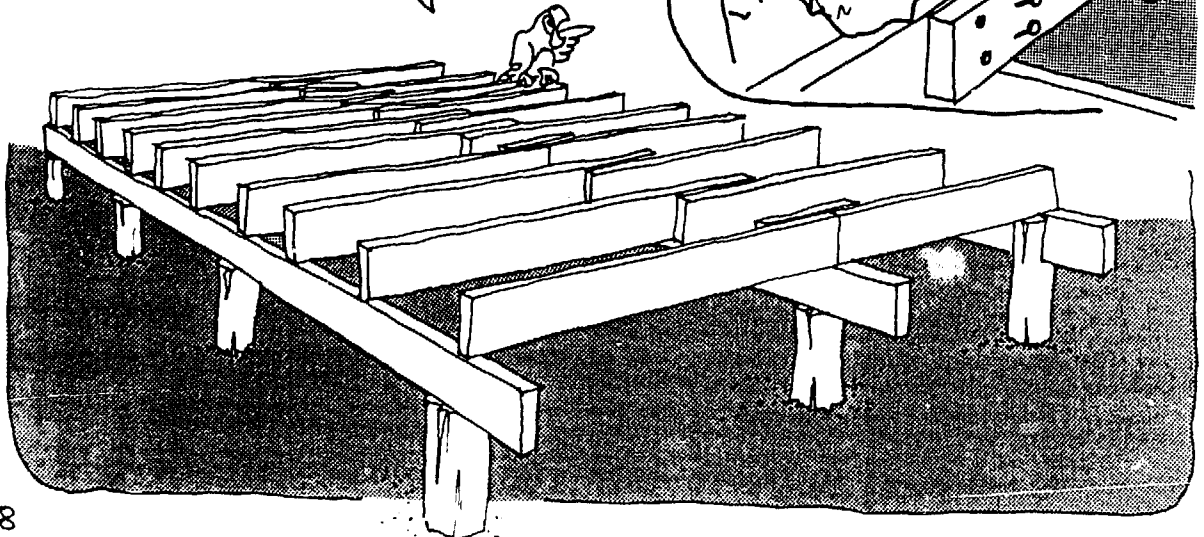
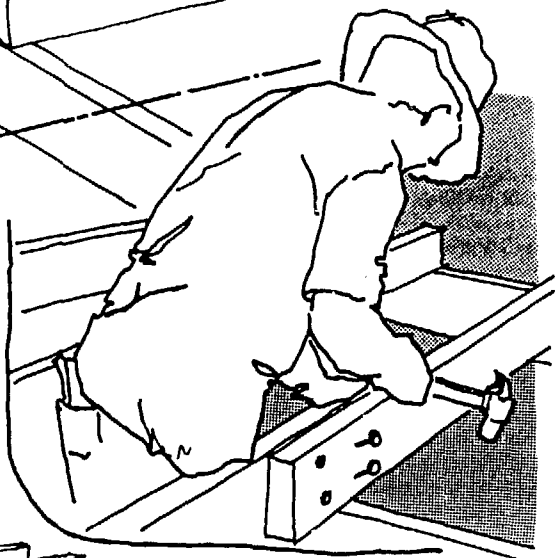

THE NAILING OF JOISTS SPACERS IS DONE LIKE THIS . . .

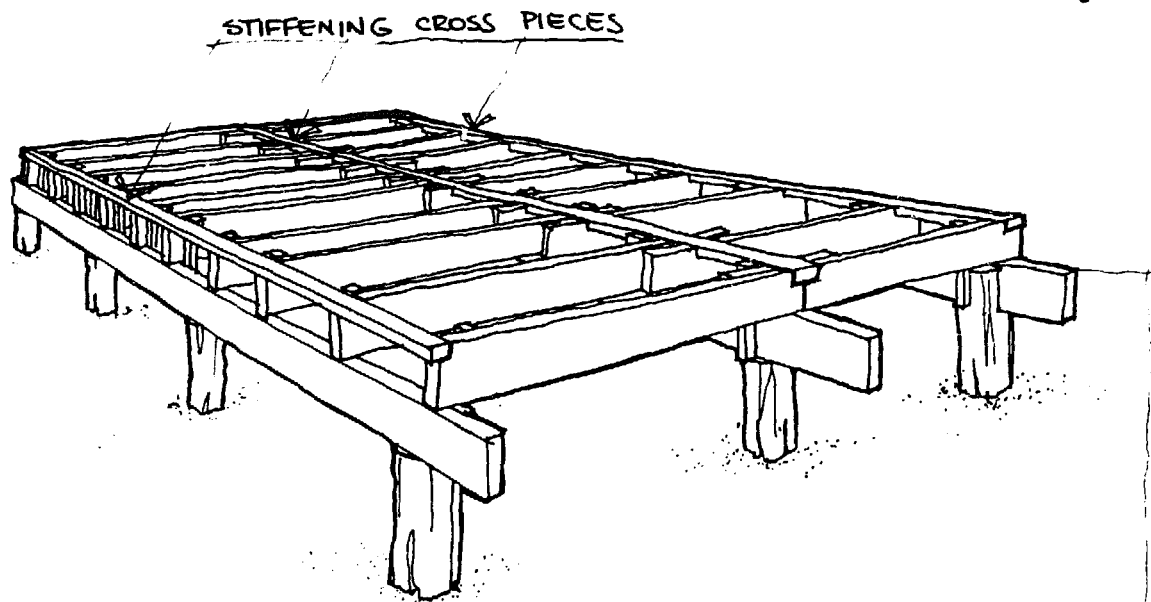
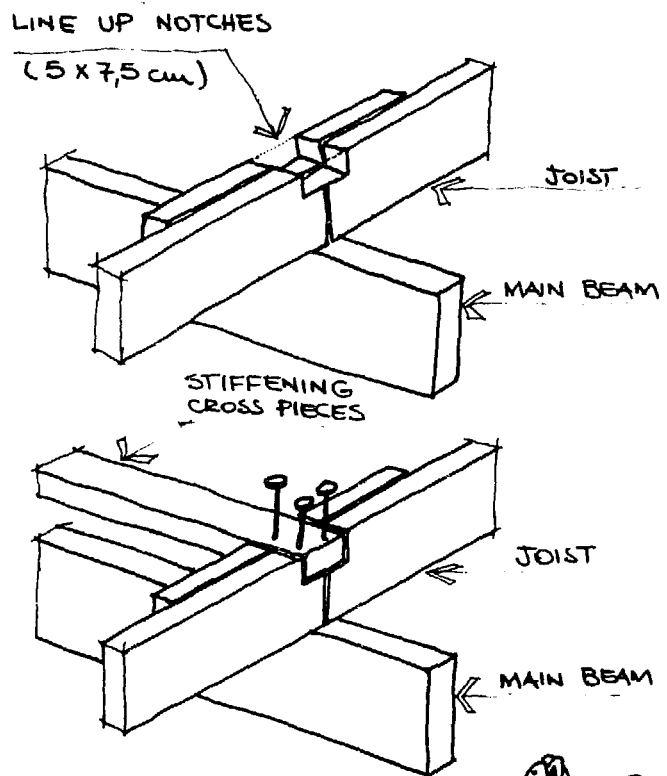
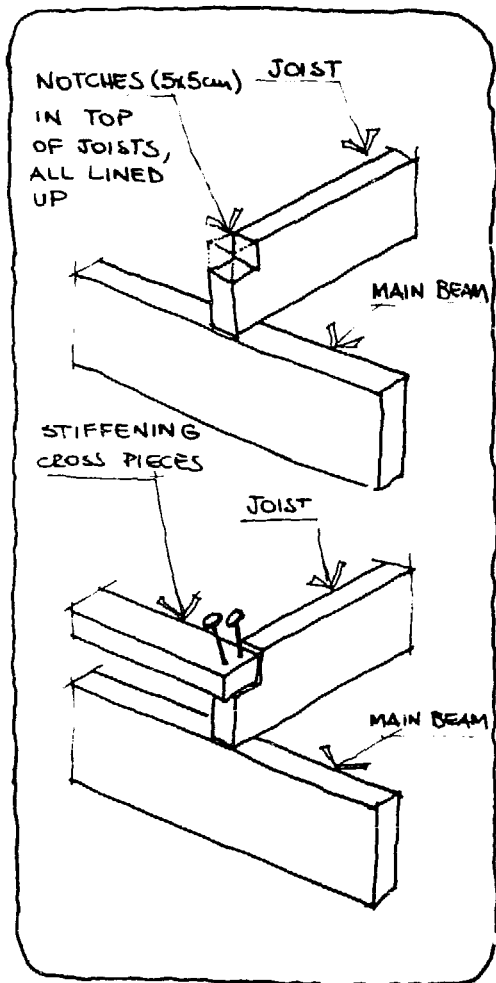

AND FINALLY YOU CAN PLACE THE FLOOR BOARDS...

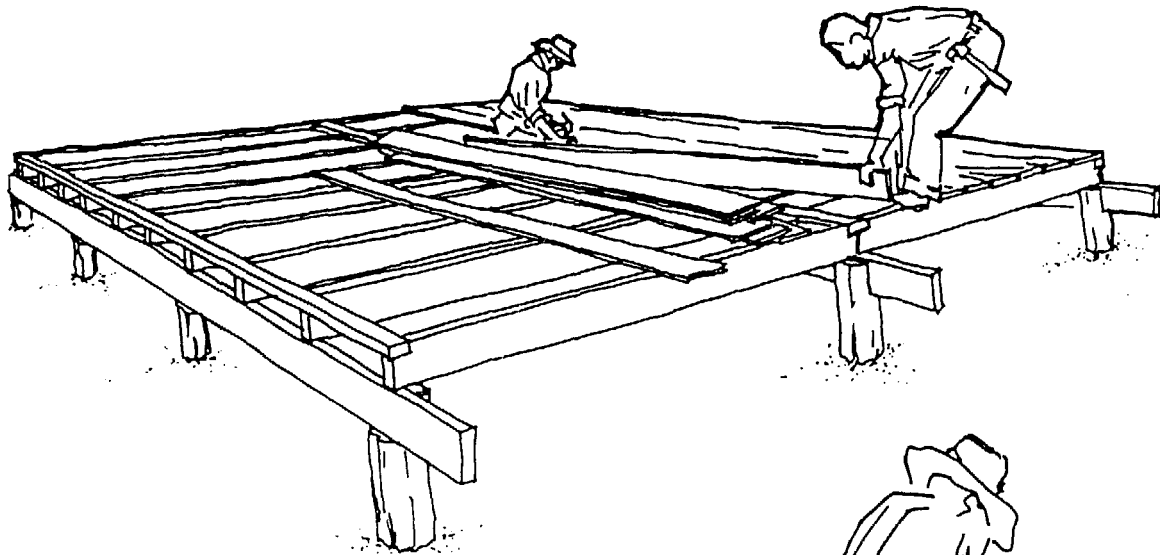

THE FLOOR BOARD JOINTS MUST BE VERY TIGHT. TO NAIL THE FLOOR BOARDS USE THREE $l = 7,5$ cm NAILS IN EACH OF THE BOARDS, ON THE LINES OF THE JOISTS.

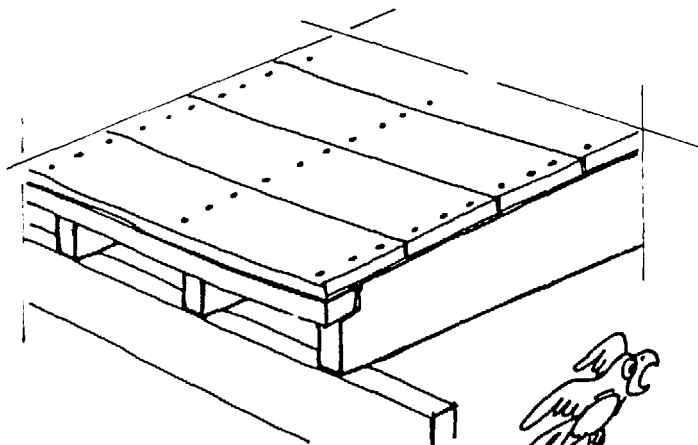
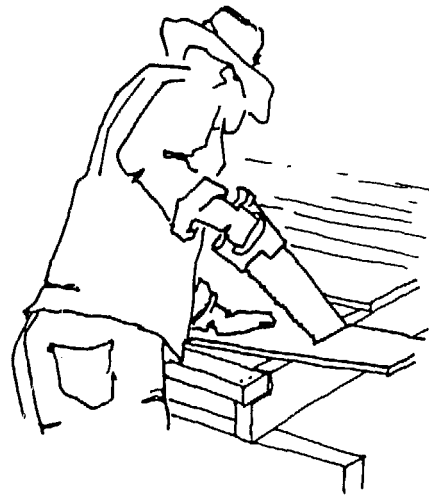

VERIFY THAT THE EDGES OF THE FLOOR PLATFORM ARE FACED AND WELL FINISHED.

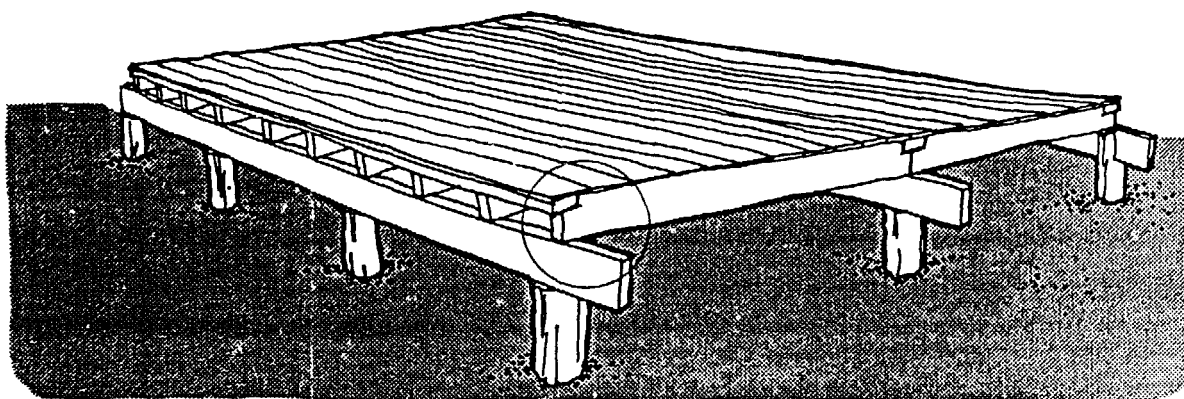

NOW THAT THE FLOOR IS READY
WE'LL PLACE THE WALLS.
THE DRAWING BELOW SHOWS THE
LAY OUT OF THE WALL PANELS:

OPEN PANELS FOR WINDOWS AND
OPEN PANELS FOR DOORS

THE OTHERS ARE SINGLE PANELS.

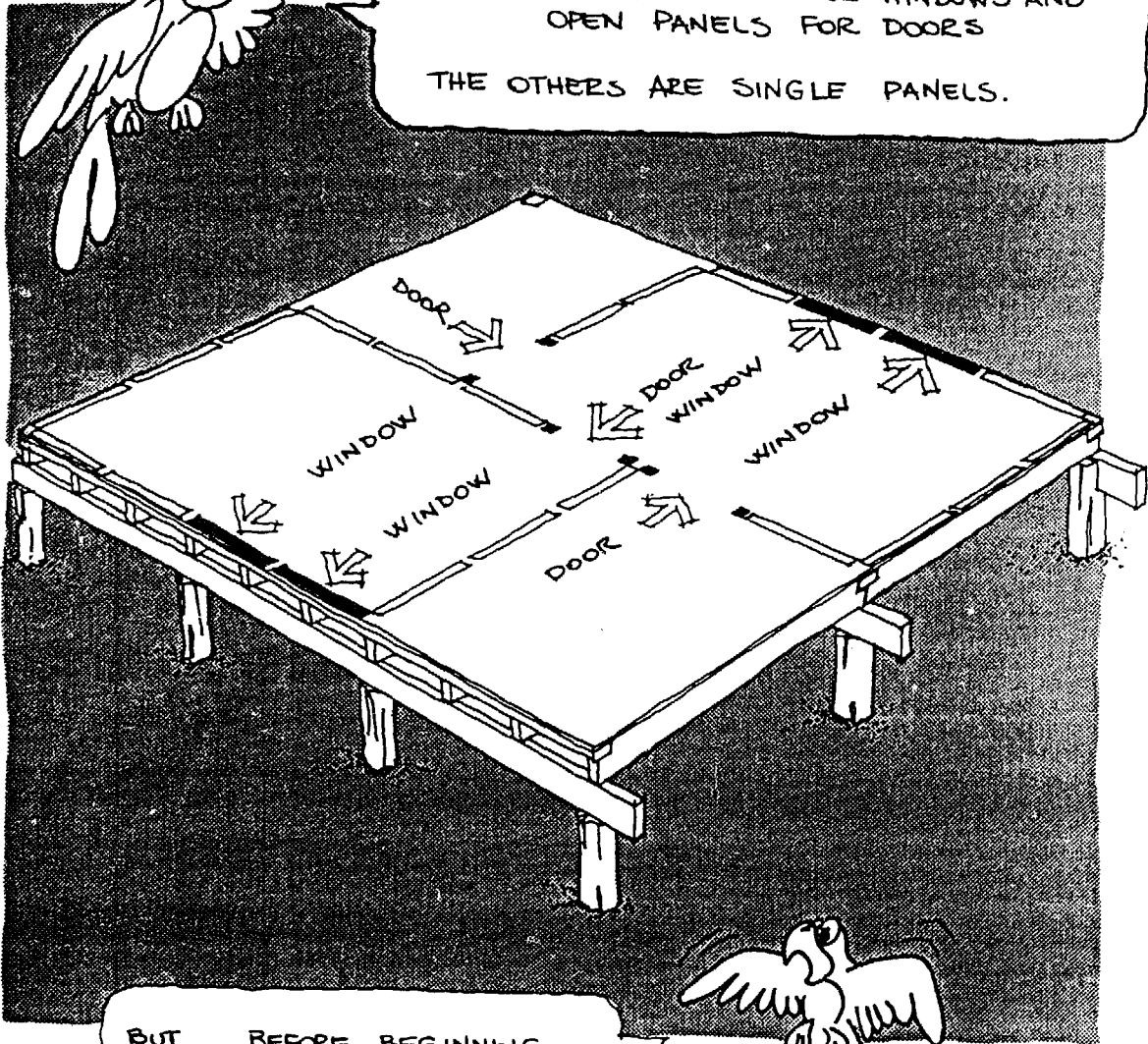

BUT... BEFORE BEGINNING
TO NAIL THE PANELS, IT'S
EASIER IF YOU DRAW
THE LINES OF THE WALLS
OR MARK THE POSITION
OF THE PANELS ON
THE FLOOR...



AND NOW WE ARE GOING TO POSITION THE PANELS!

... YOU MARK THE FLOOR LIKE THIS TO
MAKE THE POSITIONING OF PANELS EASIER.

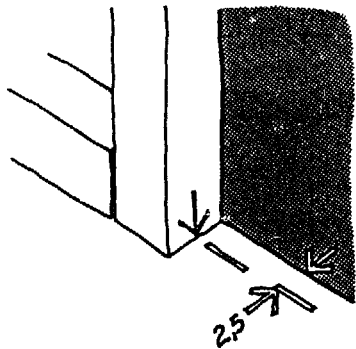
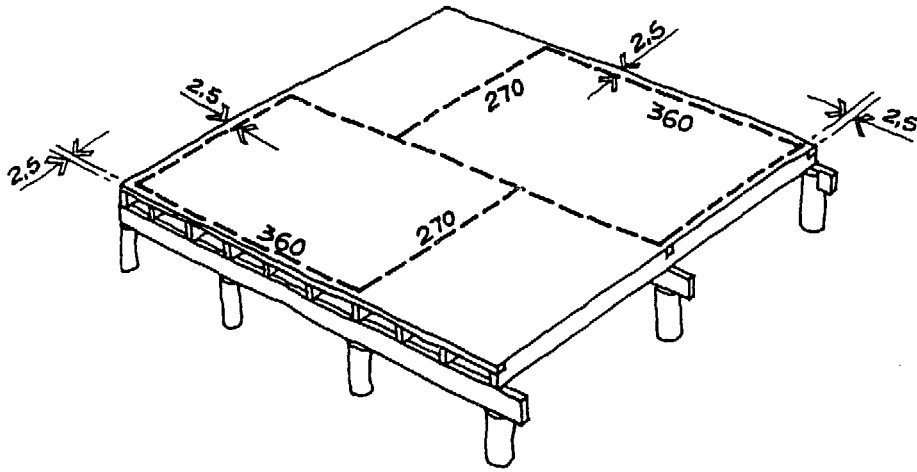

ALWAYS CONSIDER THE
LINE AS PASSING
THROUGH THE MIDDLE OF
THE PANEL FRAME.

LET'S PLACE THE FIRST
PANEL. NAIL THREE SMALL
STOPS TO MARK THE
POSITION OF THE PANELS.
NOW PUSH THE BOTTOM OF
THE PANEL AGAINST THE
STOP. LIKE THIS ...

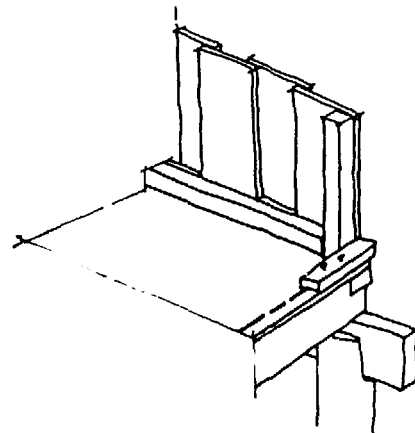
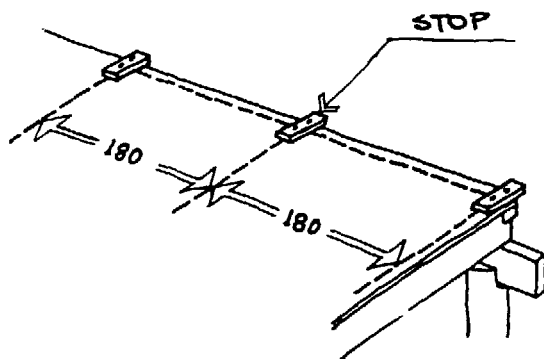

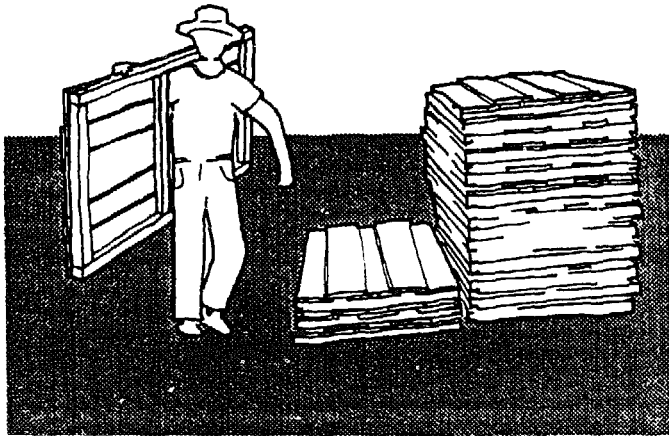

LET US BEGIN INSTALLING
THE PANELS.

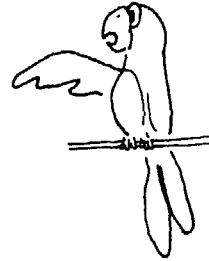

THE FIRST PANEL
IS A CORNER ONE.

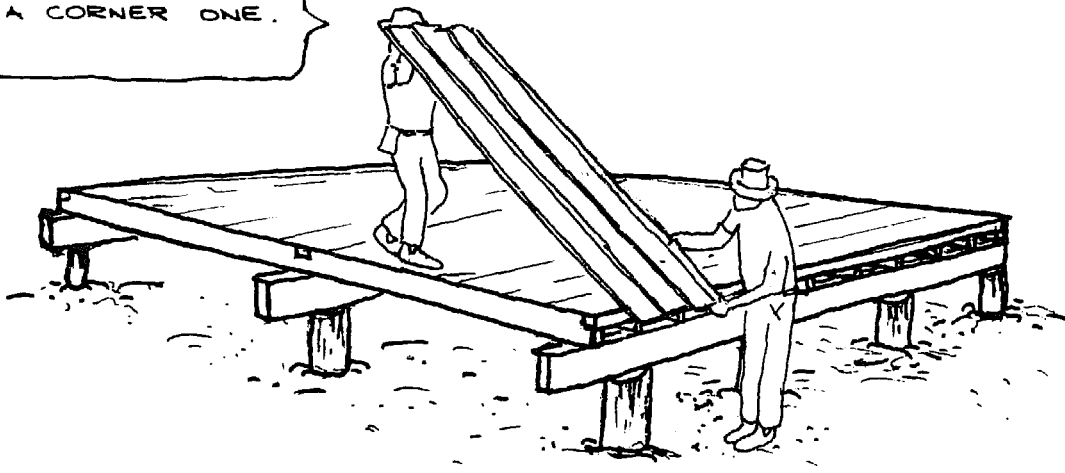

NAIL THE OUTSIDE
EDGE OF THE PANEL
WITH $l: 6,25$ cm NAILS

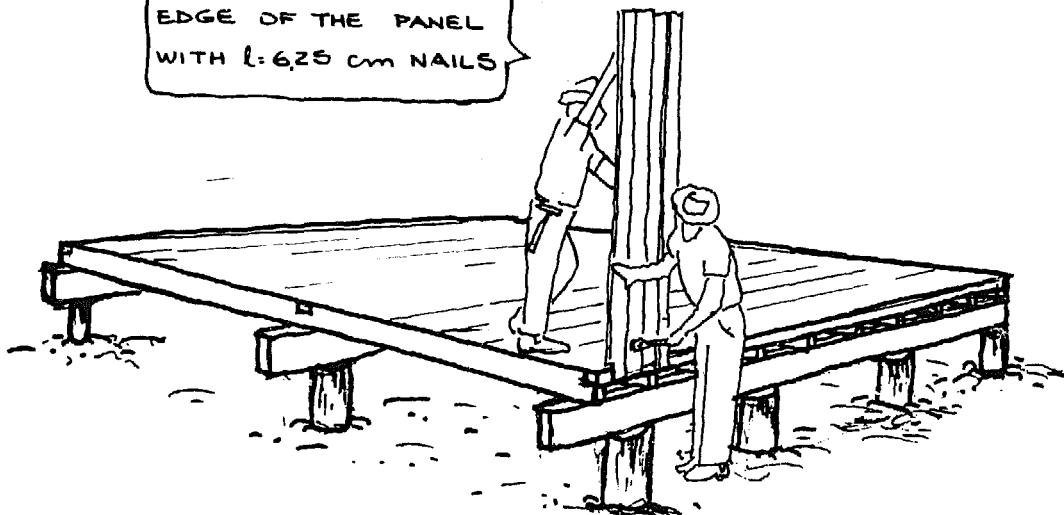

NOW FIX THE PANEL ON THE INSIDE.

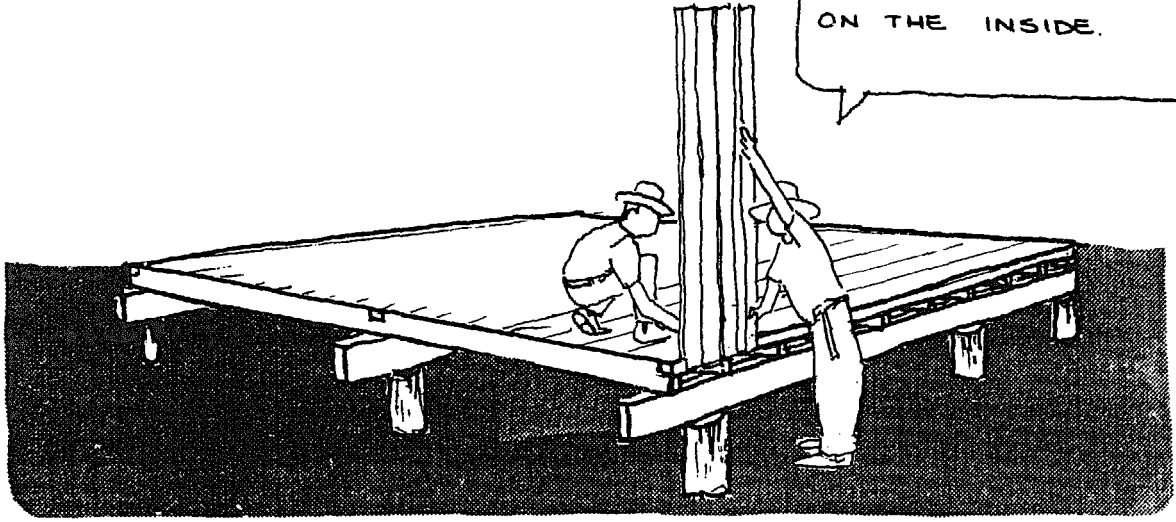

THE PANEL IS FIXED WITH
ℓ = 10 cm NAIL AT EACH CORNER

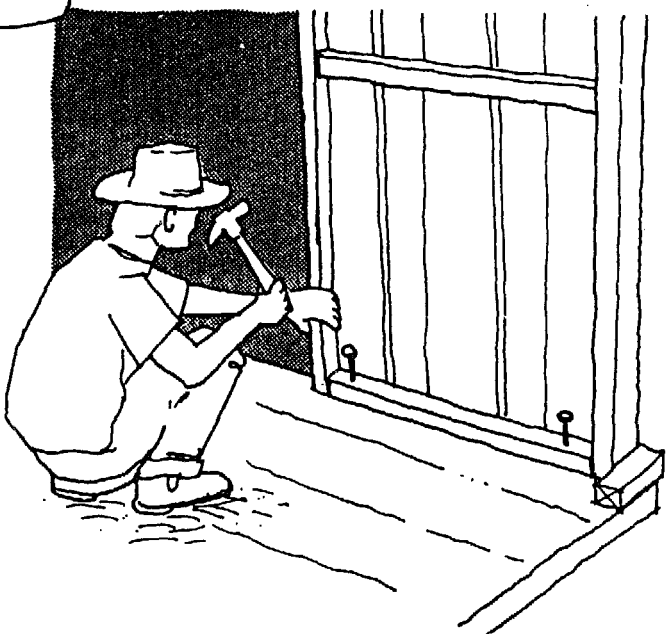

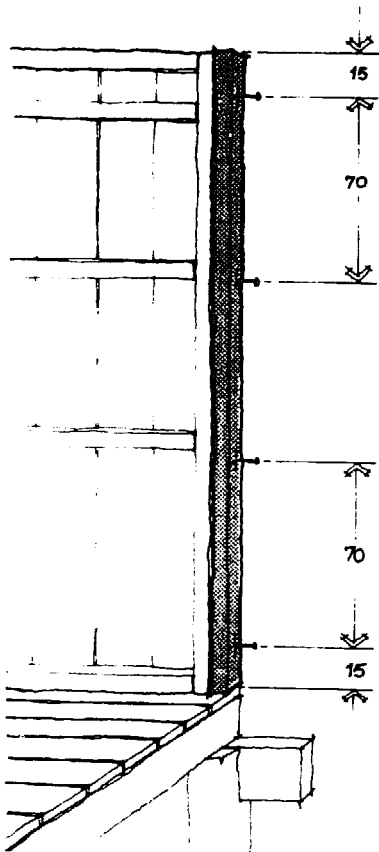

TAKE OFF THE STOP
AND NAIL AN INTER-
PANEL STUD WITH A
LENGTH OF 240 cm TIM-
BER. USE $l = 10\text{cm}$ NAILS.

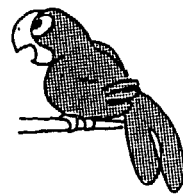

AFTER FIXING THE PANEL
UPRIGHT IT MUST BE PROPPED
UP TO AVOID TIPPING
OVER.

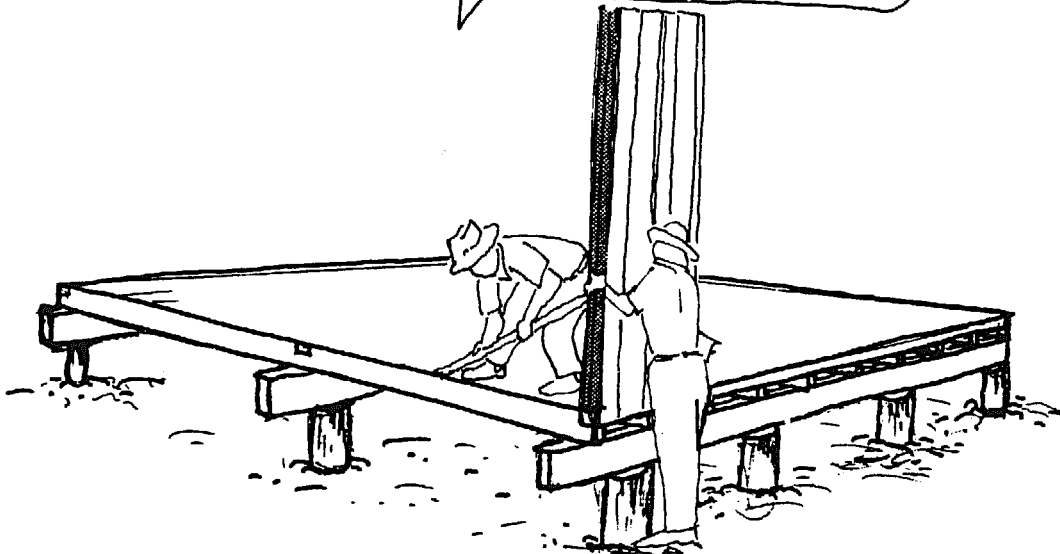

NOW RAISE THE SECOND PANEL.
CHECK THAT THE BOTTOM OF THE PANEL
IS PUSHED UP AGAINST THE STOP AT
THE OTHER SIDE.

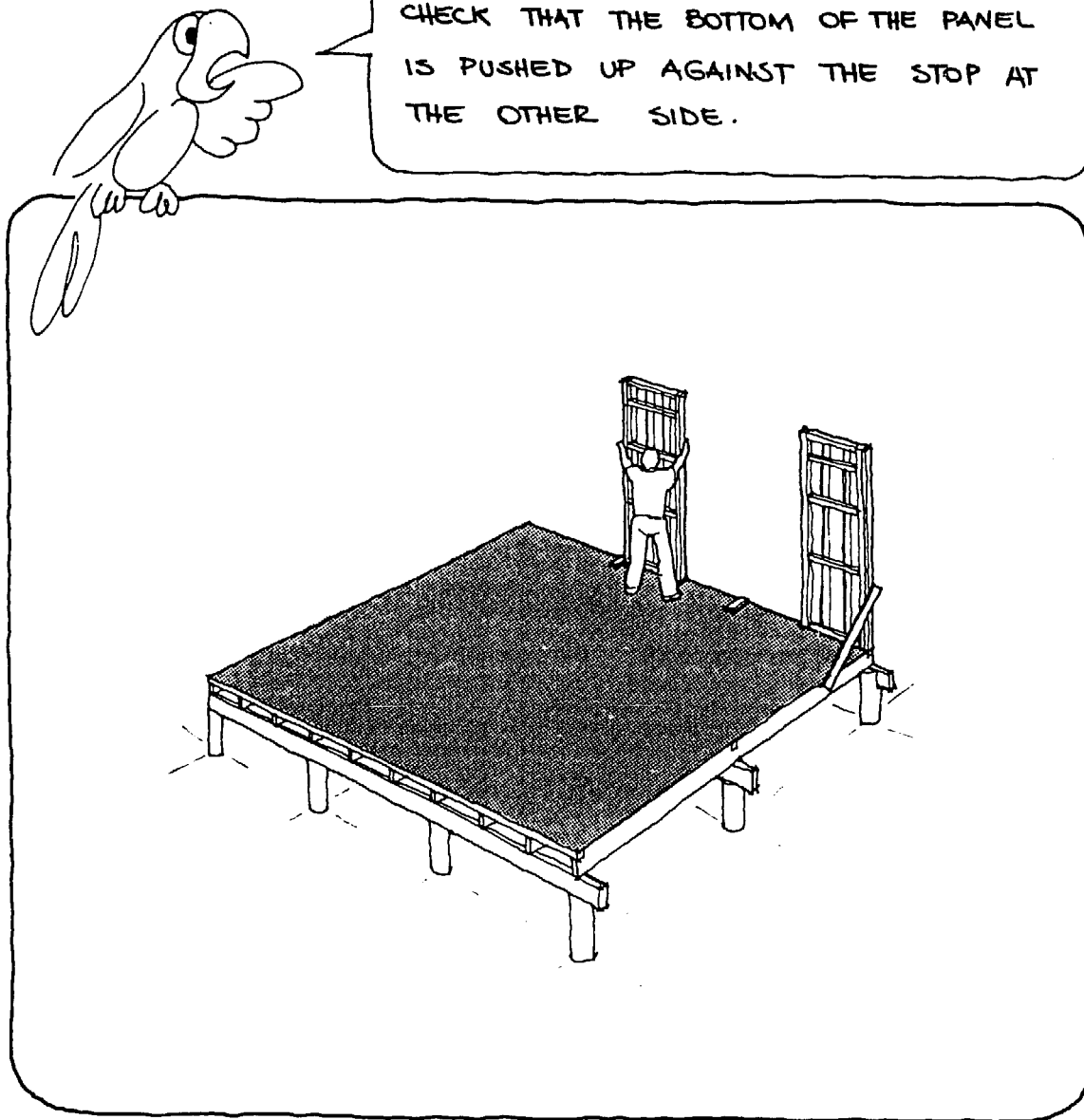

AFTER NAILING THE PANEL AND
CHECKING THAT IT IS VERTICAL, YOU
ALSO PROP IT UP WITH A BOARD.
NOW FOR THE THIRD PANEL ...

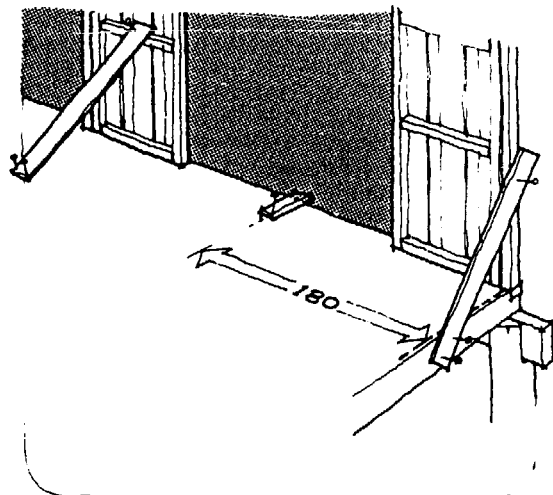

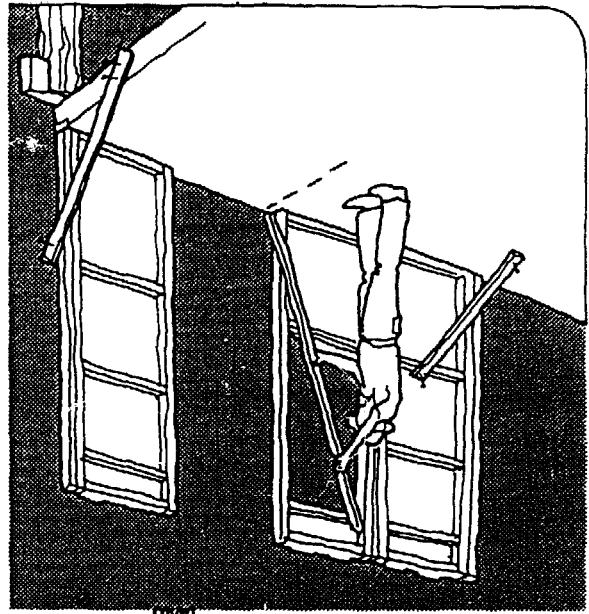
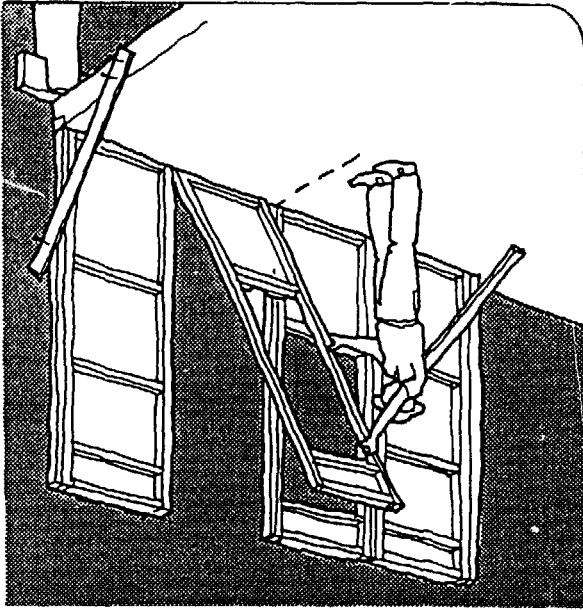

THEN TAKE OFF THE STOP AND NAIL ANOTHER INTER-PANEL STUD AS WAS DONE WITH THE FIRST ONE. NOW YOU CAN ERECT THE LAST PANEL OF THIS WALL. NAIL THE INTER-PANEL STUD TOO.

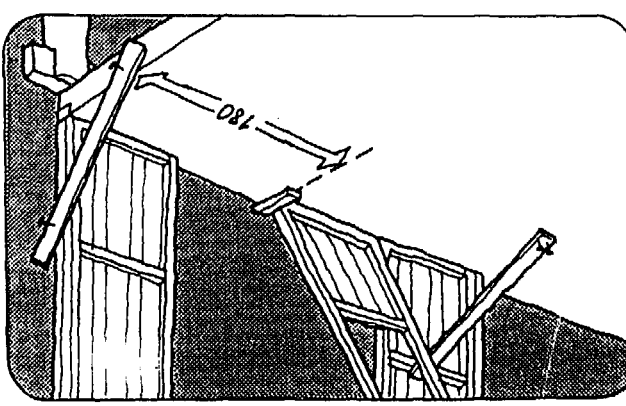
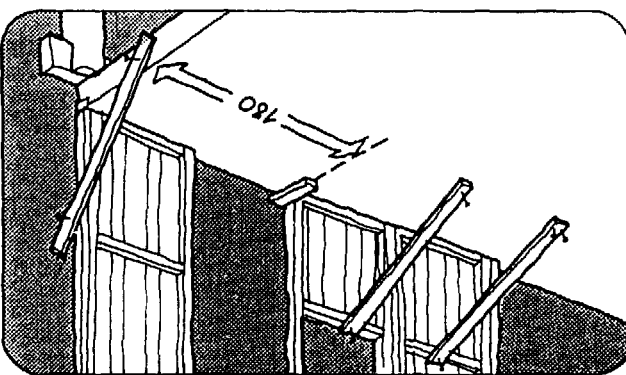
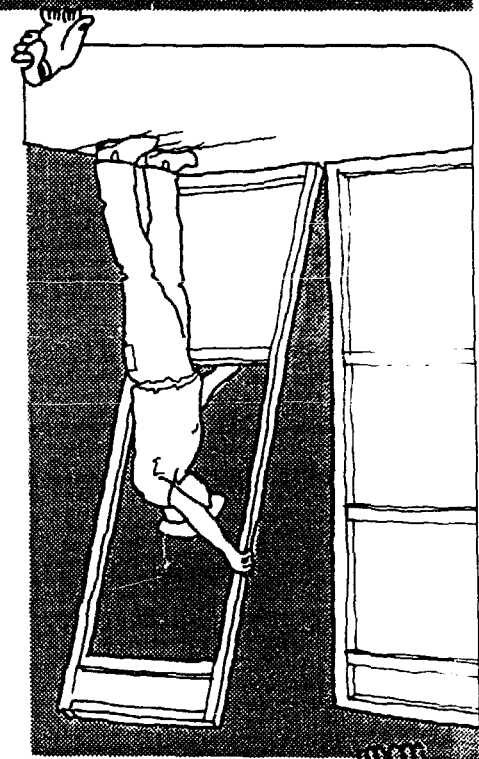

PROP THE THIRD PANEL AGAINST THE MIDDLE STOP. PUT IT VERTICAL USING A PLUMB BOB. NAIL AND SUPPORT IT.



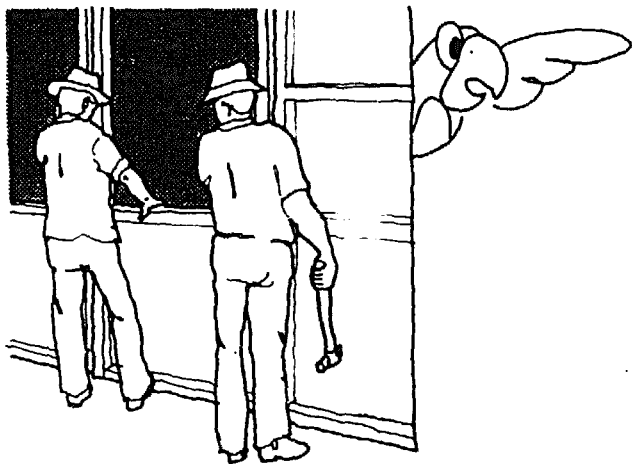

DON'T FORGET TO NAIL
A WOOD CLEAT
ON
THE PANELS IN ORDER
TO FASTEN THE PANELS
FIRMLY TOGETHER.

AND HERE IS THE
FIRST WALL READY!
IT WAS EASY,
WASN'T IT?

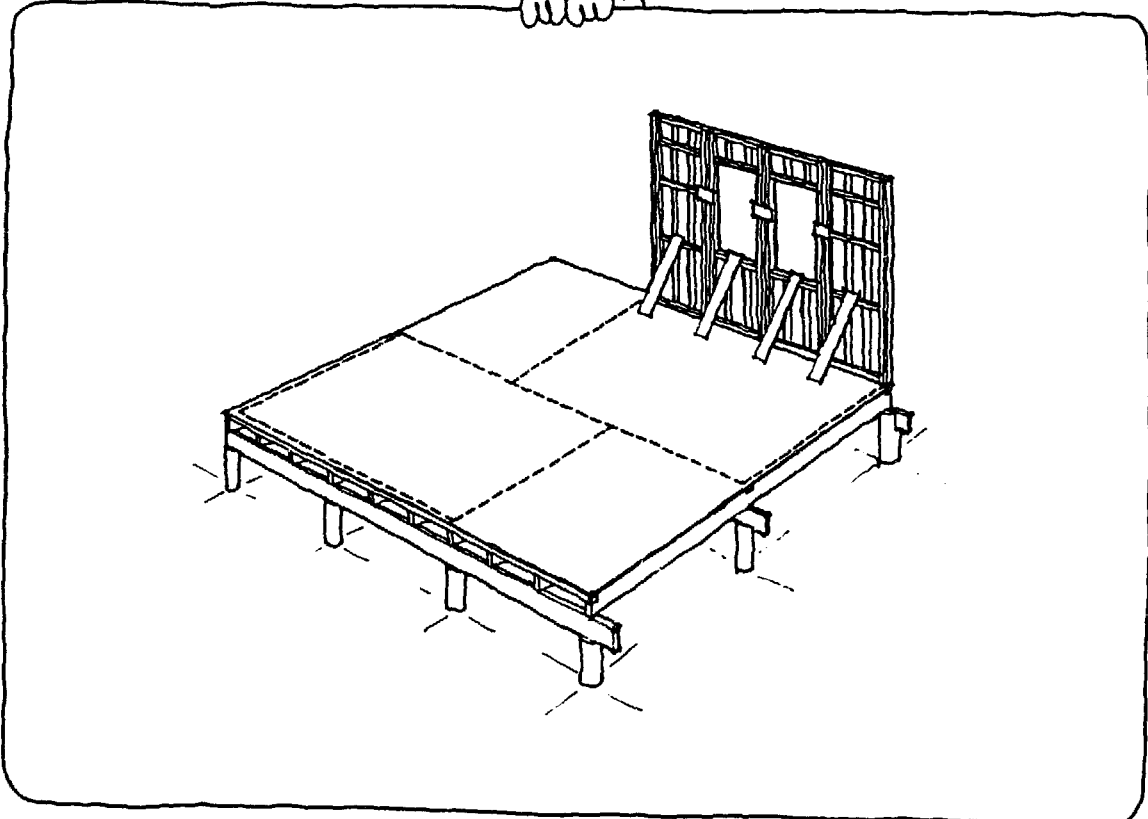
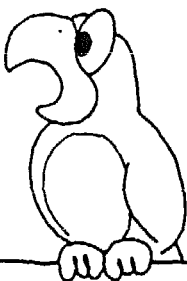



NOW THAT YOU HAVE LEARNED HOW TO MOUNT THE PANELS JUST KEEP ON PUTTING THE OTHERS UP.

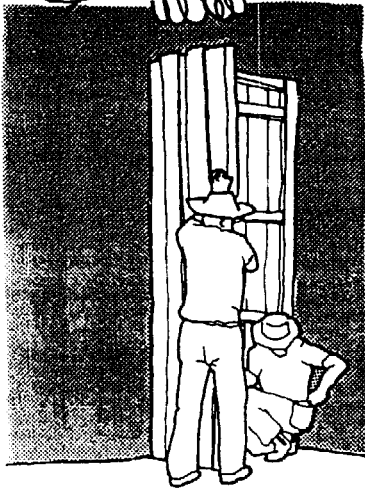

FOR THOSE PANELS THAT ARE GOING TO BE INSTALLED DIRECT ON THE FLOOR BOARDS AND NOT AT AN EDGE, DON'T FORGET TO SAW OFF THE LENGTH OF BOARD JUTTING OUT BEYOND THE FRAME.

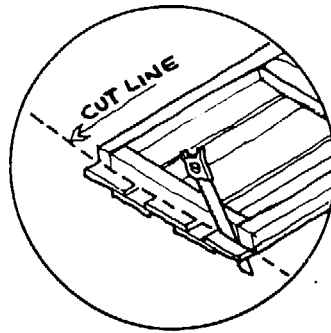

FIX THE DOOR PANEL ON THE FLOOR WITH TWO NAILS IN EACH STUD, LEAVING 2,5 cm FROM THE LINE OF THE MIDDLE WALL. CHECK THE PLUMB AND SUPPORT IT.

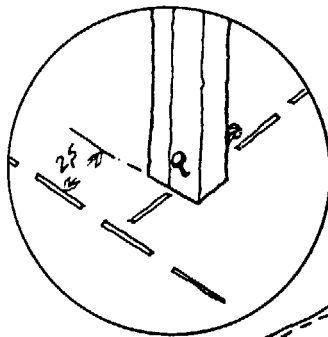
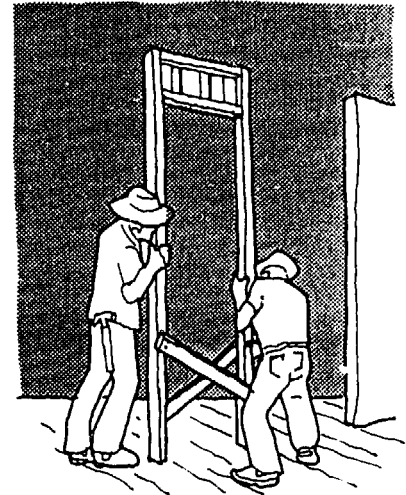

NAIL THE MIDDLE PANEL AFTER CENTERING IT IN THE GAP, DIVIDING EQUALLY THE SPACE ON EACH SIDE. CHECK THE PLUMB AND SUPPORT IT. JOIN THE PANELS TOGETHER WITH CLEATS TO STABILIZE THEM.



AND SO, THE SECOND WALL IS READY!



NOW THE MIDDLE WALL.
YOU ARE GOING TO
UTILIZE INTER-PANEL
STUDS :

5 x 5 x 325 CM IN
LENGTH

THEY WILL SUPPORT
THE RIDGE BEAM

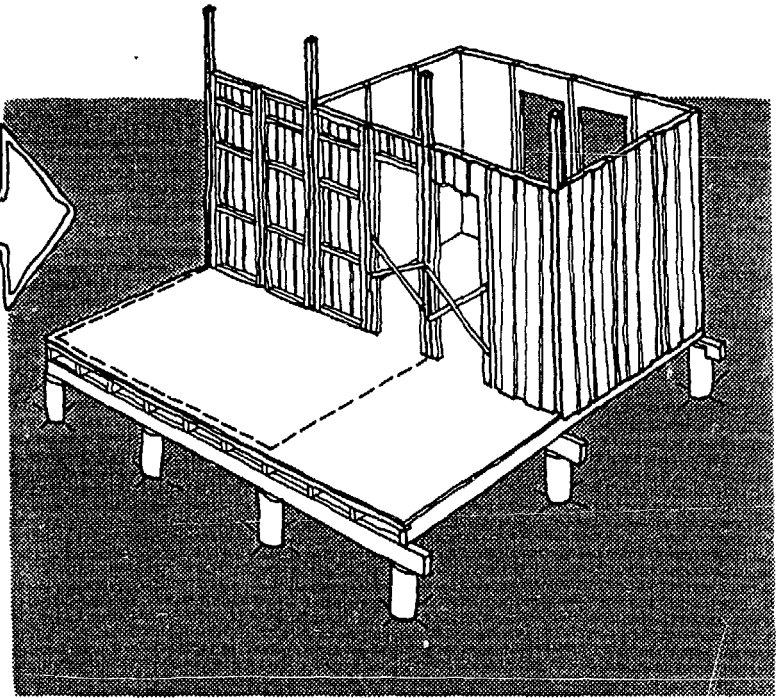

THE FINISHING
OF THE FLOOR
FRAME IS DONE
BY PLACING ONE
BOARD OF
2,5 X 20 CM
COVERING THE
JOISTS ENDS.

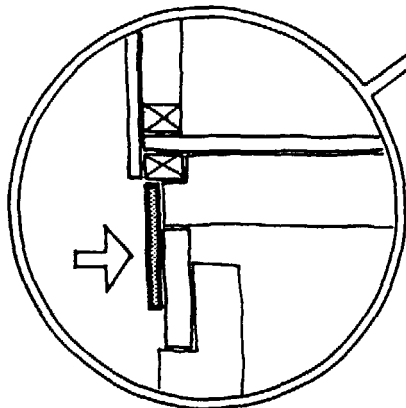
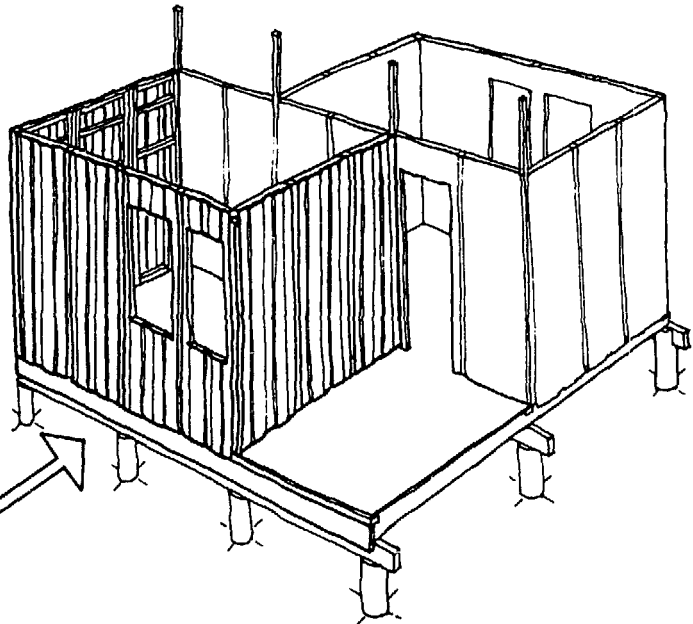



AND, TO COMPLETE THE SUPPORT OF THE ROOF FRAME, YOU INSTALL THE PORCH POST AND BEAM.

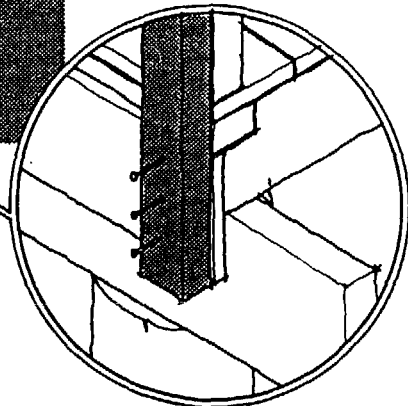
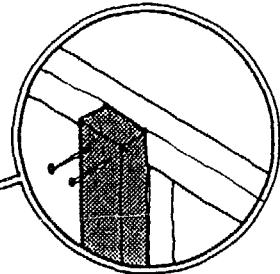
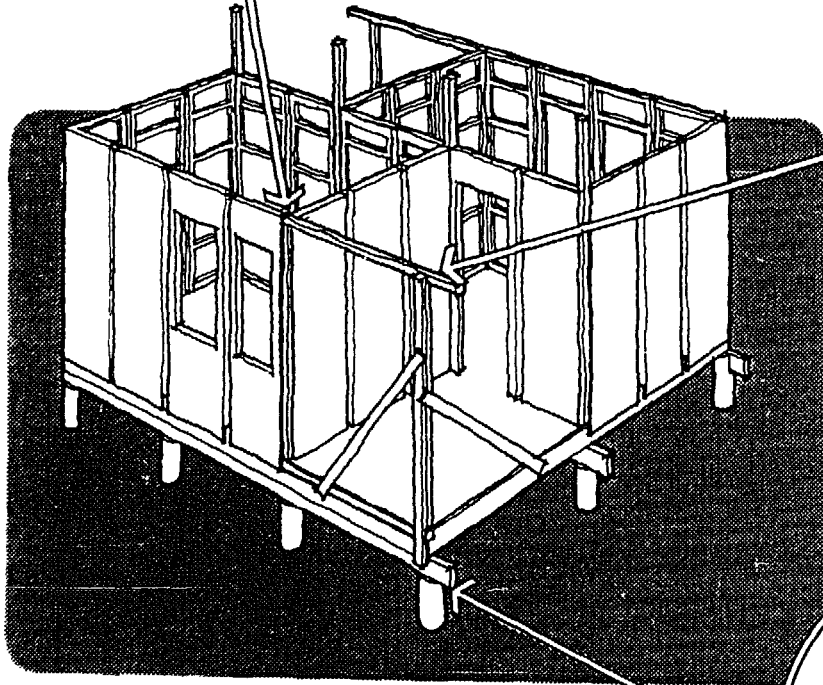
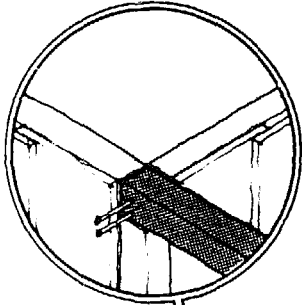

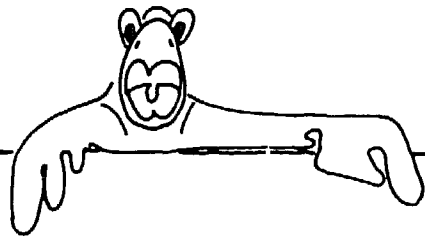

ATTENTION !

YOU MUST TAKE SOME CARE WHEN NAILING THE TOP PLATE.

- USE ONE $l = 10$ cm NAIL EVERY 45 cm
- ALWAYS USE, IF POSSIBLE, WHOLE PIECES
- MAKE A JOINT ONLY IN THE MIDDLE OF THE PANEL.
- EXPOSED SIDES ARE FACED.

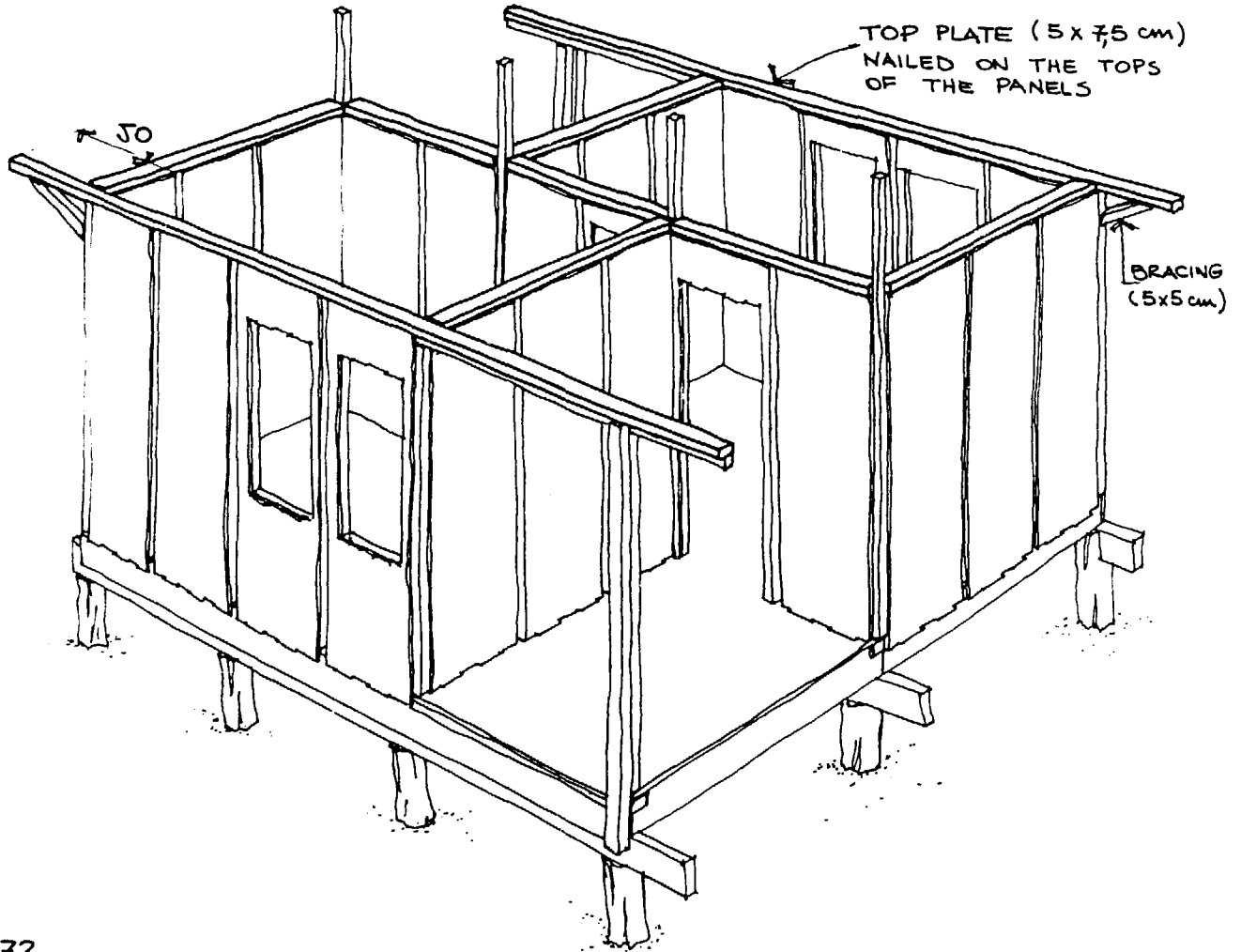
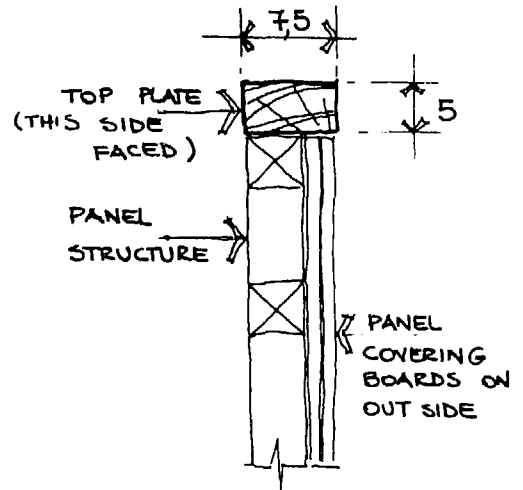

NOW WE ARE GOING TO BUILD
THE **ROOF FRAME**

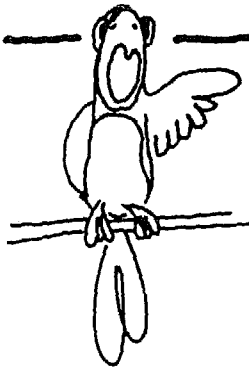

YOU BEGIN MOUNTING
THE ROOF FRAME BY
JOINING AND FIXING
THE RIDGE BEAM.

THE RIDGE BEAM IS
COMPOSED OF TWO
BEAMS OF 197,5 cm IN
LENGTH AND ONE OF
245 cm.

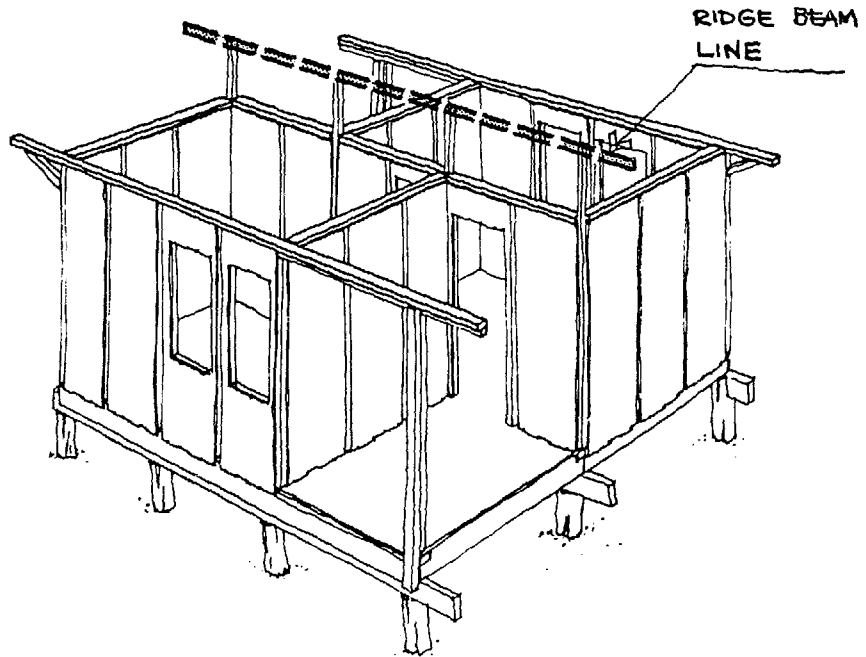

THREE $l=6,75$ NAILS
EACH SIDE

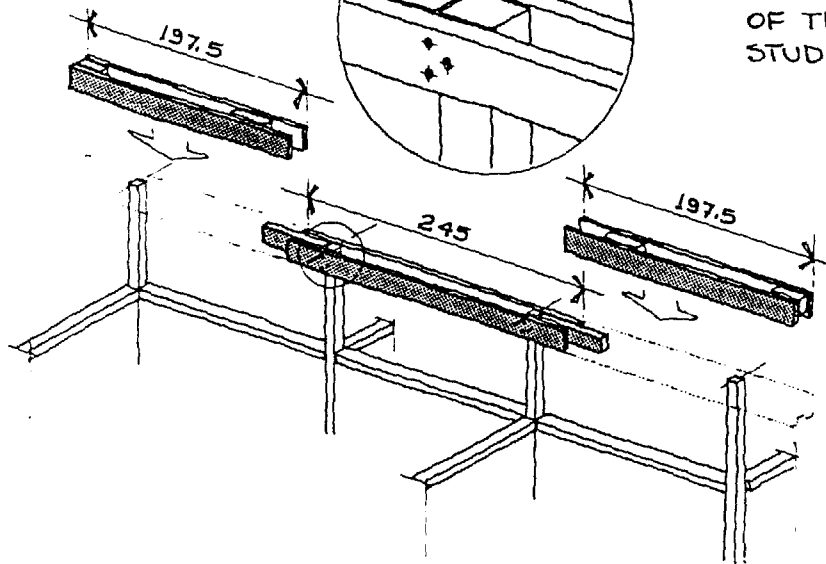

THE RIDGE BEAM IS
FIXED ON THE
OF THE INTER-PANEL
STUDS.

YOU INSTALL A
BRACING STRUT, LIKE THIS ...

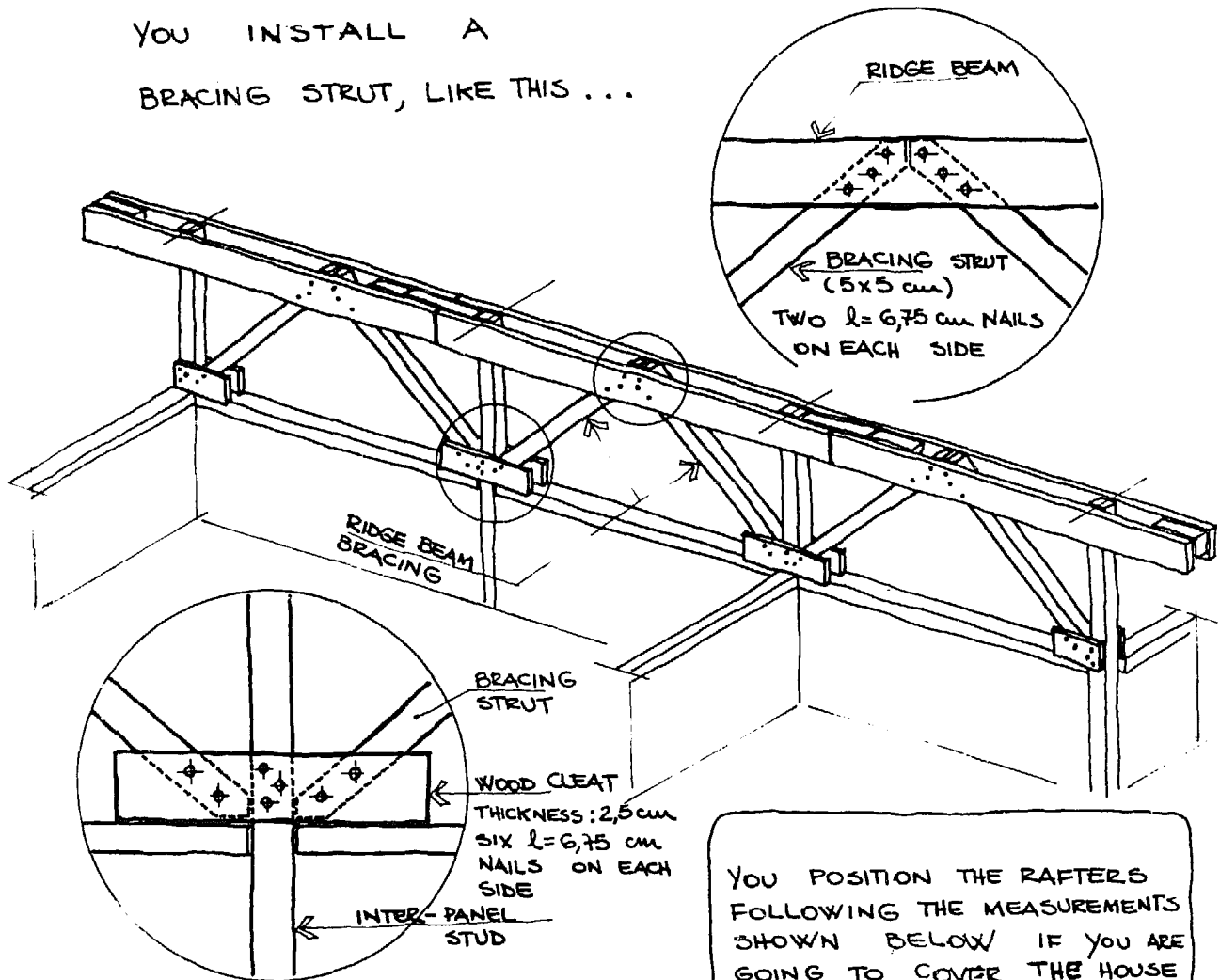

YOU POSITION THE RAFTERS FOLLOWING THE MEASUREMENTS SHOWN BELOW IF YOU ARE GOING TO COVER THE HOUSE WITH ASBESTOS-CEMENT OR ALUMINIUM SHEETS OR SIMILAR.

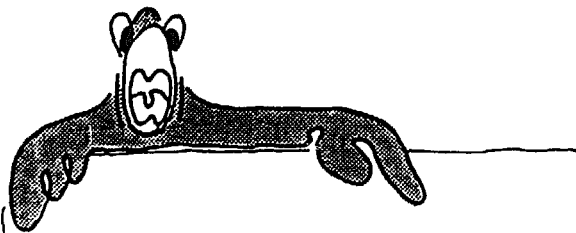

IF YOU ARE GOING TO USE CLAY ROOF TILES, THE RAFTERS HAVE A MAXIMUM SPACING OF 45 cm.

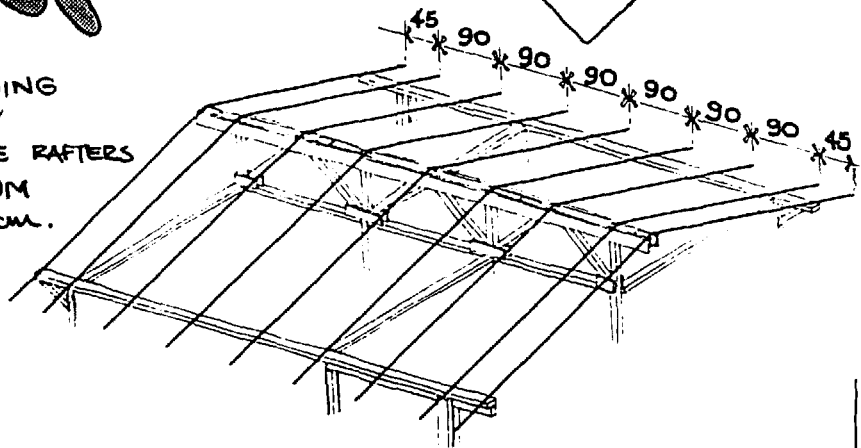

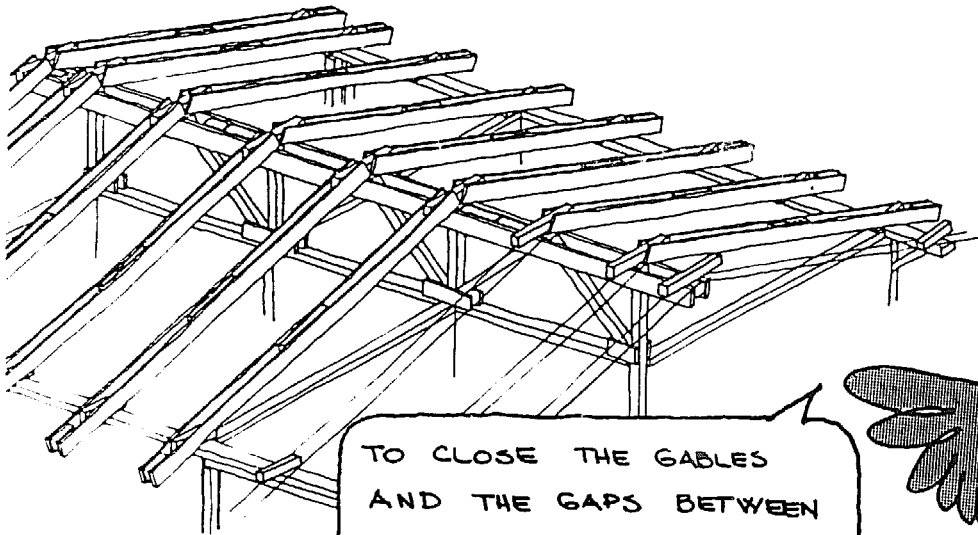

TO CLOSE THE GABLES AND THE GAPS BETWEEN THE MIDDLE WALL PANELS AND THE ROOF FRAMES YOU CAN CHOOSE BETWEEN :

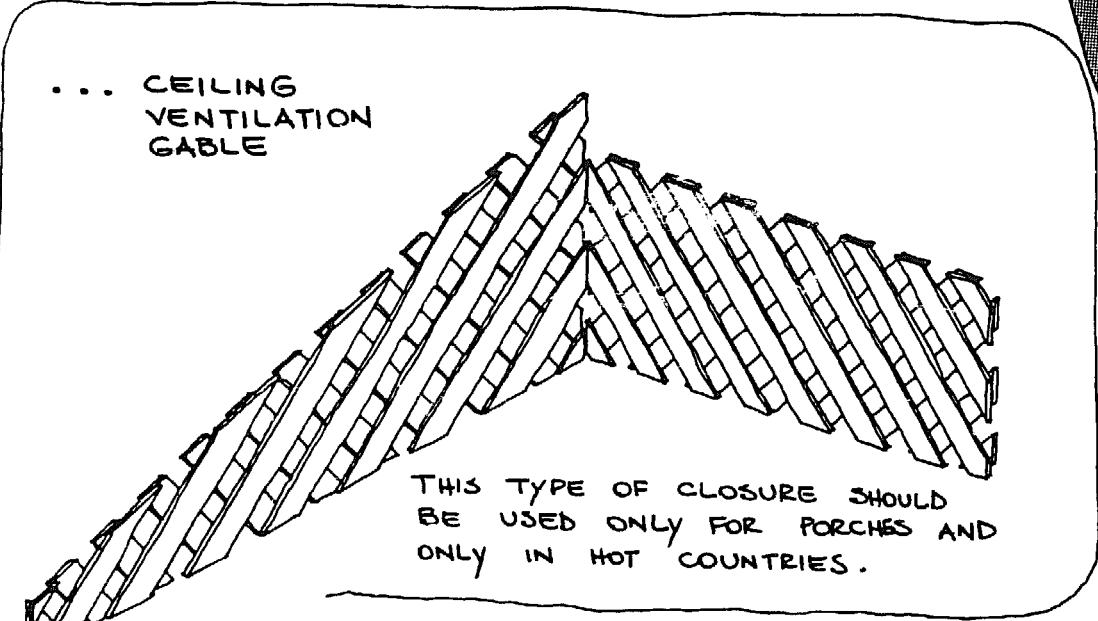
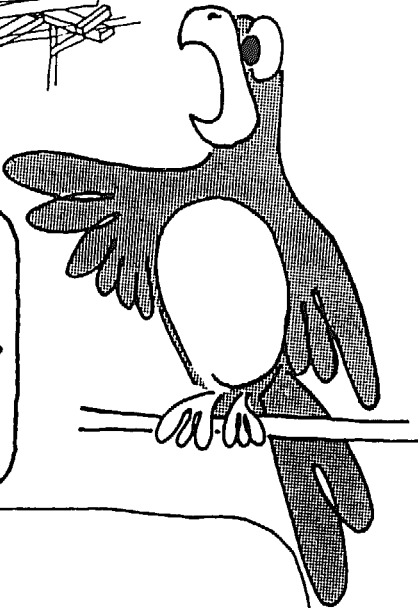

... OR CLOSED GABLE

YOU USE THIS TYPE OF CLOSURE WHEN VENTILATION IS NOT NEEDED OR WHEN A PROTECTION FROM WIND AND RAIN IS NECESSARY.

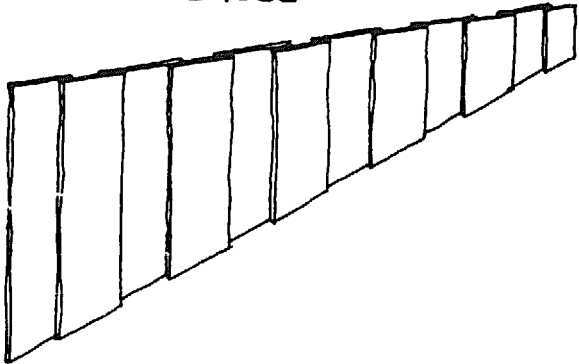

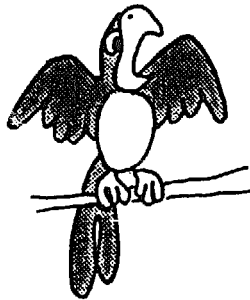

THE RAFTERS ARE LOCATED
END TO END ON THE RIDGE
BEAM BY A WOOD
SPlicing BLOCK OF
5 x 5 x 30 cm WHICH
HAS BEEN NAILED TO
THE RIDGE BEAM
WITH 4 $l=7,5$ cm NAILS.

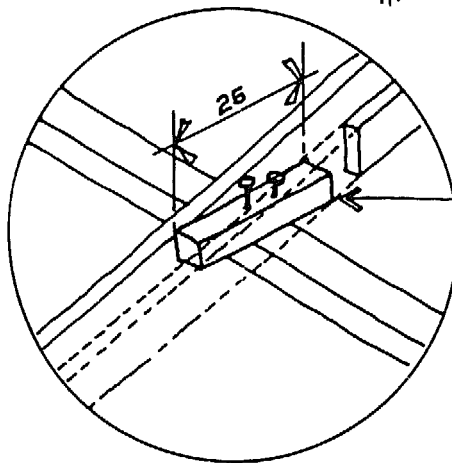
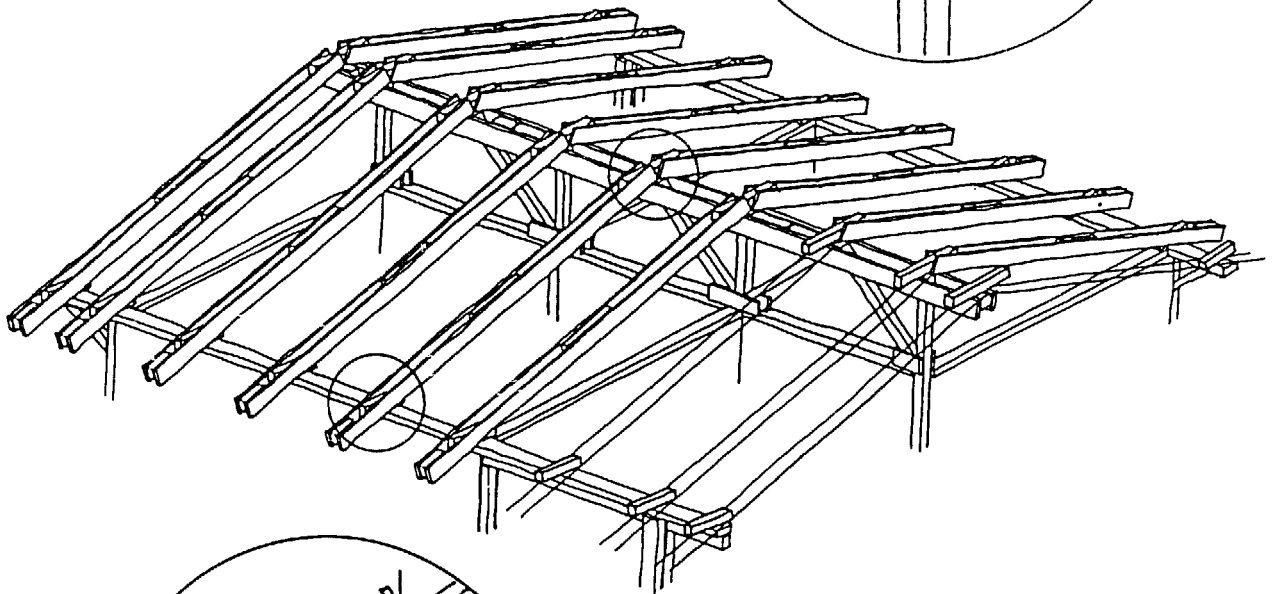
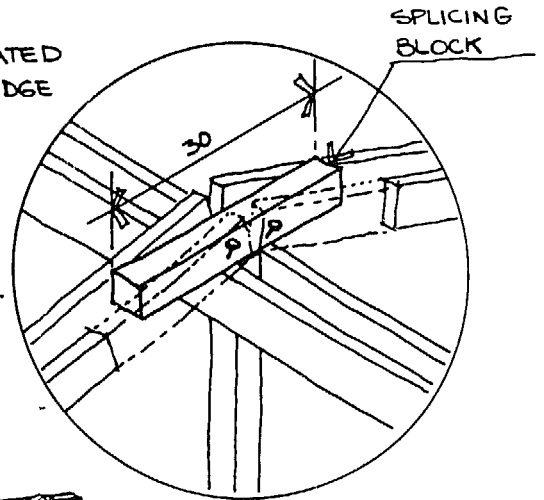

SPlicing BLOCK



THE RAFTERS ARE LOCATED ON THE TOP
PLATE BY A WOOD SPlicing BLOCK OF
5 x 5 x 25 cm NAILED TO THE TOP PLATE
WITH 2 $l=10$ cm NAILS.



NOW YOU ARE GOING TO SEE HOW THE RAFTERS ARE FIXED.

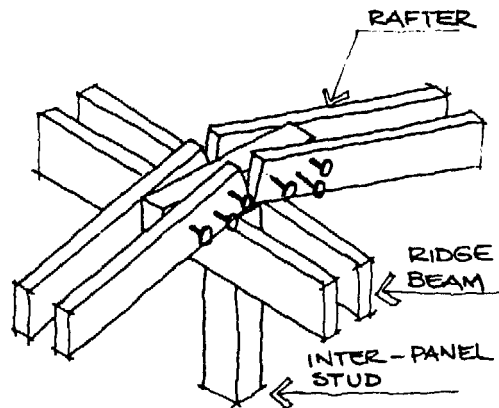
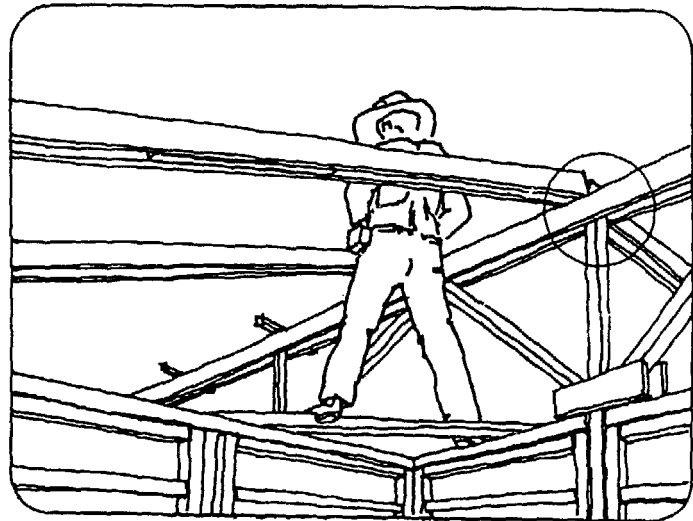

RAFTERS ARE FIXED ON RIDGE BEAM AND ON TOP PLATES WITH $l = 7,5$ cm NAILS (ON BOTH SIDES) LIKE THIS...

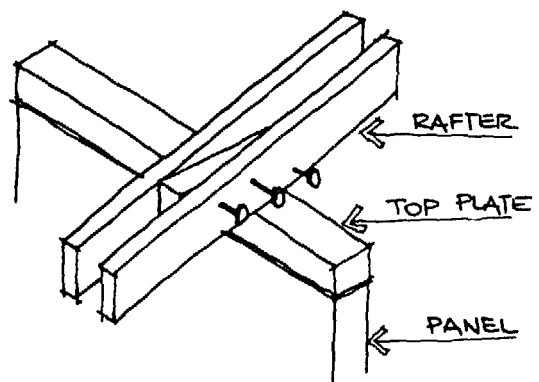
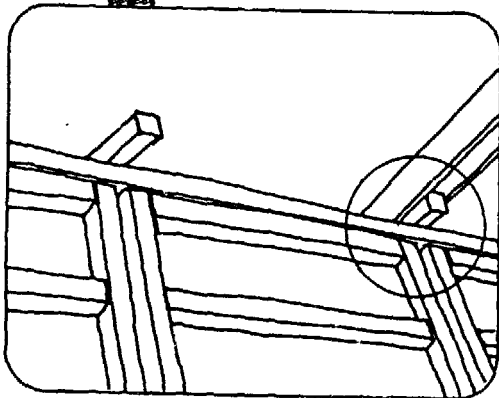

ANCHORING THE RAFTERS TO RIDGE BEAM...

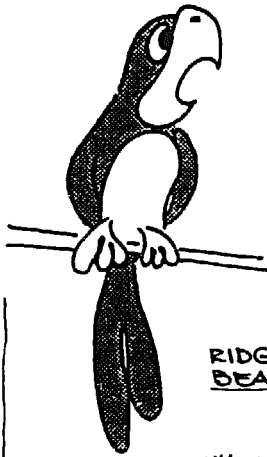

TO ANCHOR THE RAFTERS TO THE RIDGE BEAM USE TWO 5x5 cm WOOD CLEATS (OR METAL STRAPS) NAILED WITH $l=8,75$ cm NAILS.

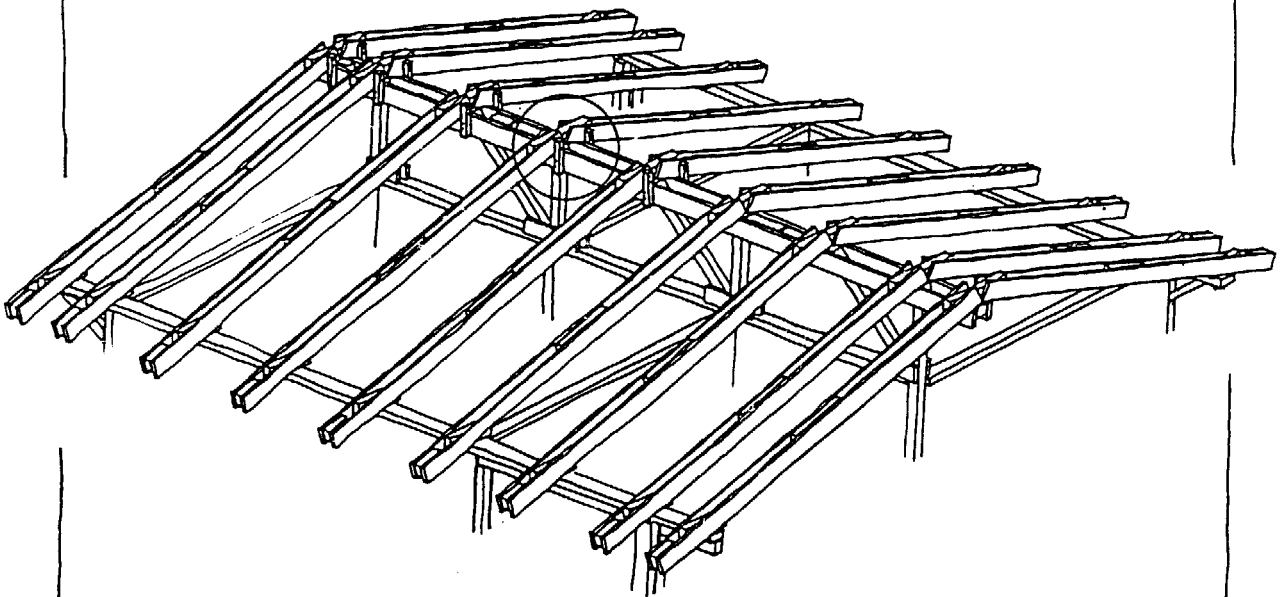
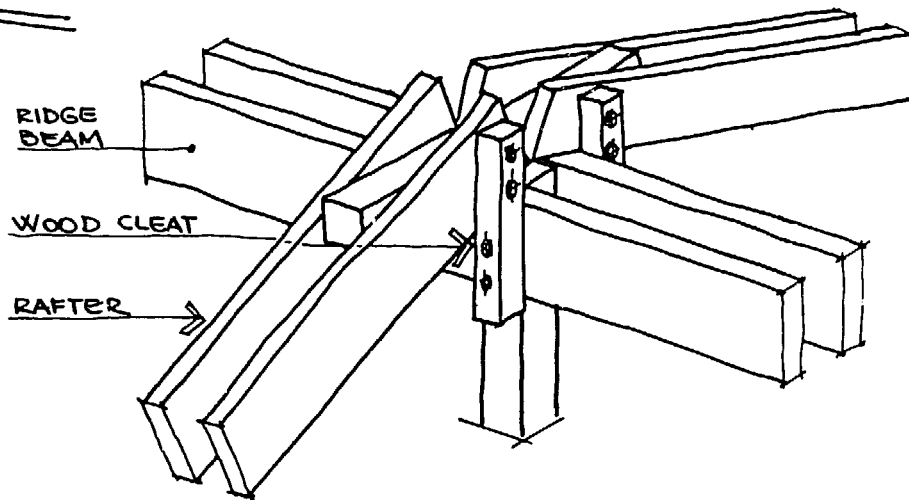

TO FINISH THE WALLS...

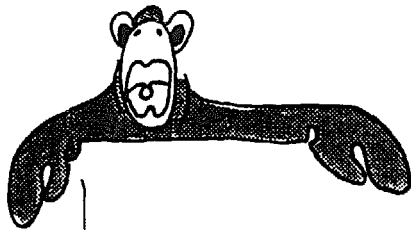
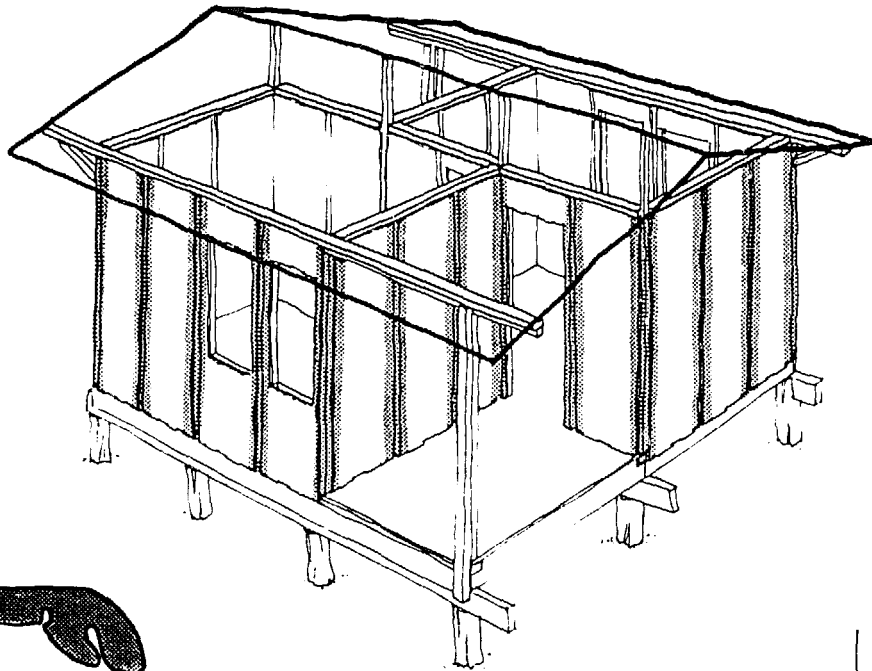

YOU COVER THE GAPS BETWEEN
THE PANELS WITH BOARDS.
THESE BOARDS ARE THE SAME TYPE
AS USED FOR THE PANEL COVERING.

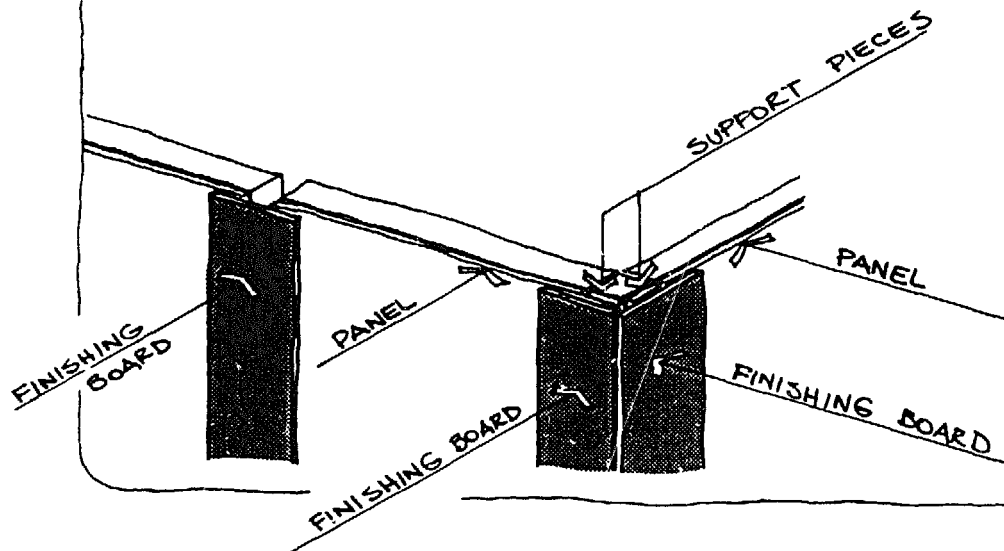

HERE IS HOW THE PURLINS SHOULD BE NAILED...

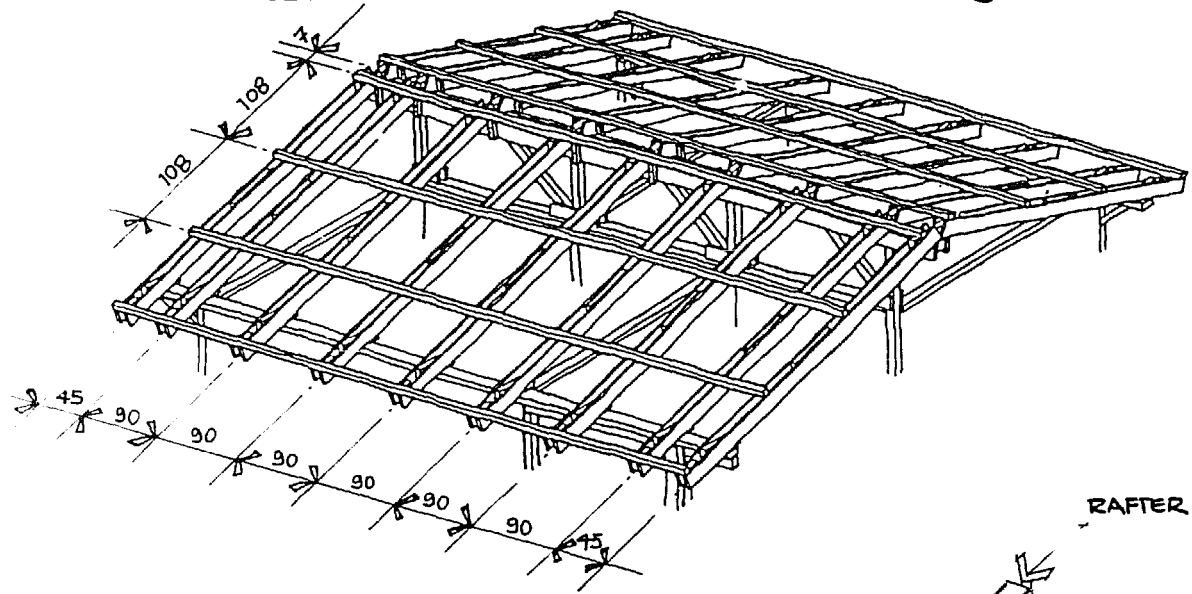
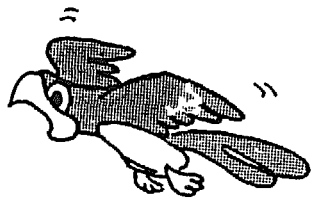

POLLY TOLD ME THAT I MUST FIX THE PURLINS WITH, AT LEAST, TWO NAILS ON EACH SUPPORT.

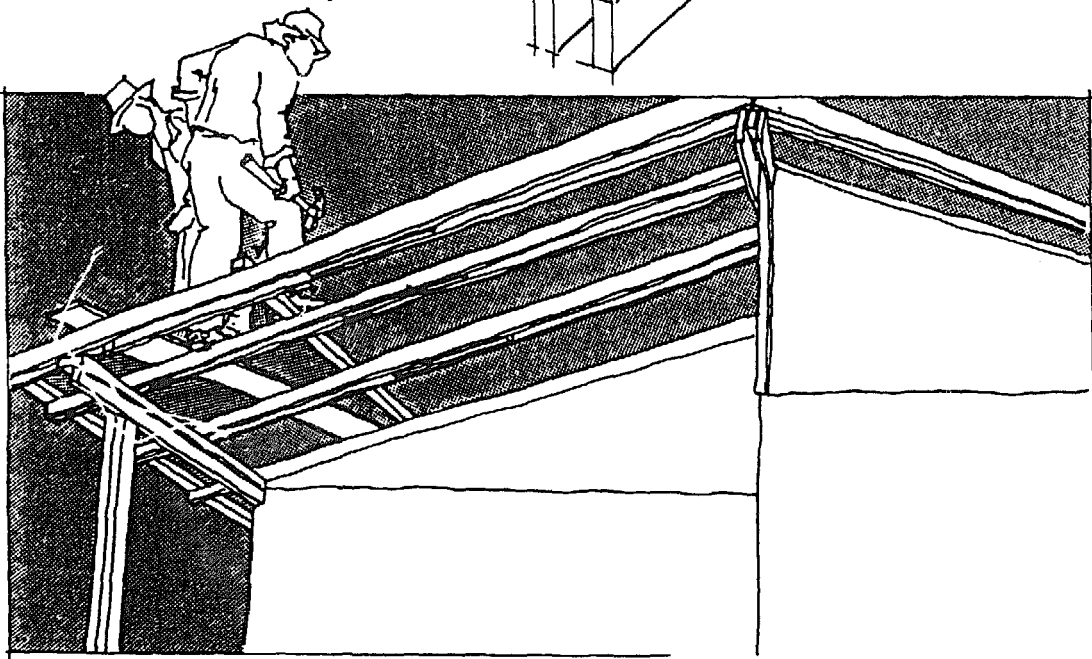
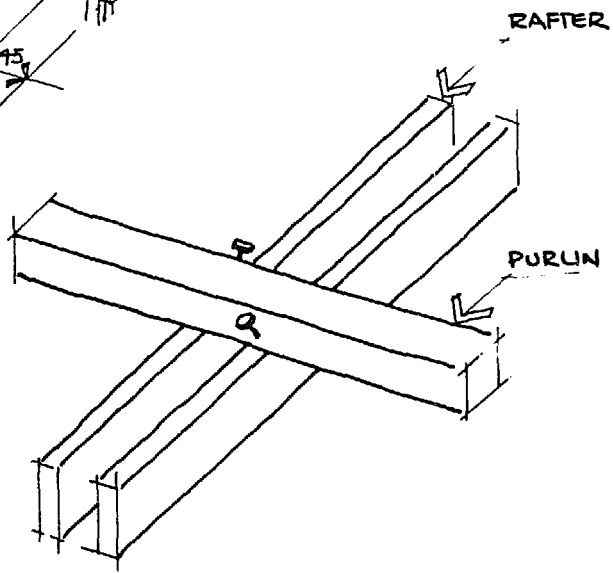

THE PURLINS HAVE BEEN PLACED AS RECOMMENDED BUT, BEFORE YOU CAN LAY THE TILES, THERE IS JUST ONE MORE TASK...

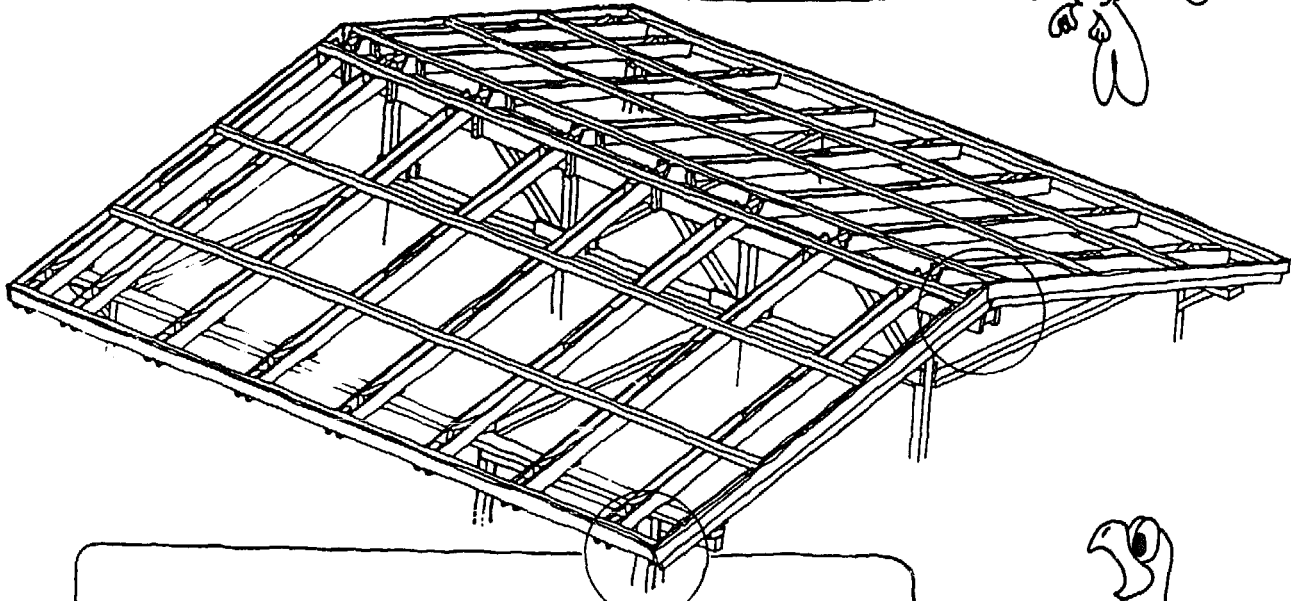

YOU NAIL BATTENS (2,5 x 10 cm) ON THE ENDS OF THE PURLINS AND ROOF BEAMS.

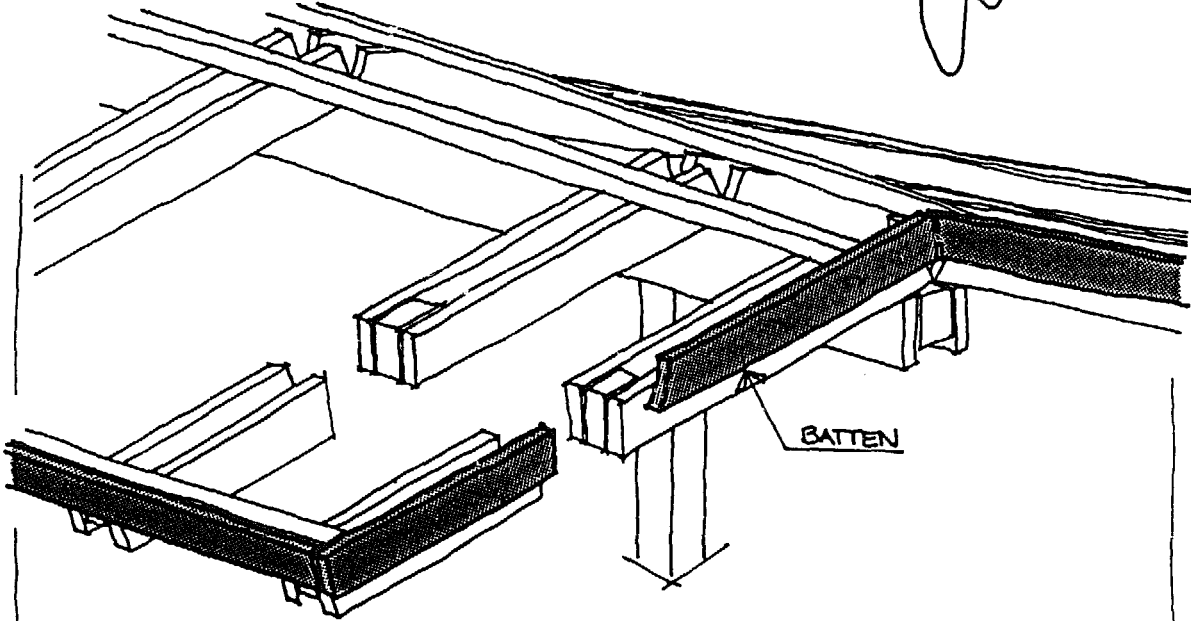

READY !

AND NOW WE CAN LAY ON THE ROOF

YOU FIX THE TILES (THESE CAN BE OF 4 MILLIMETRES) AND THE ROOF IS READY!

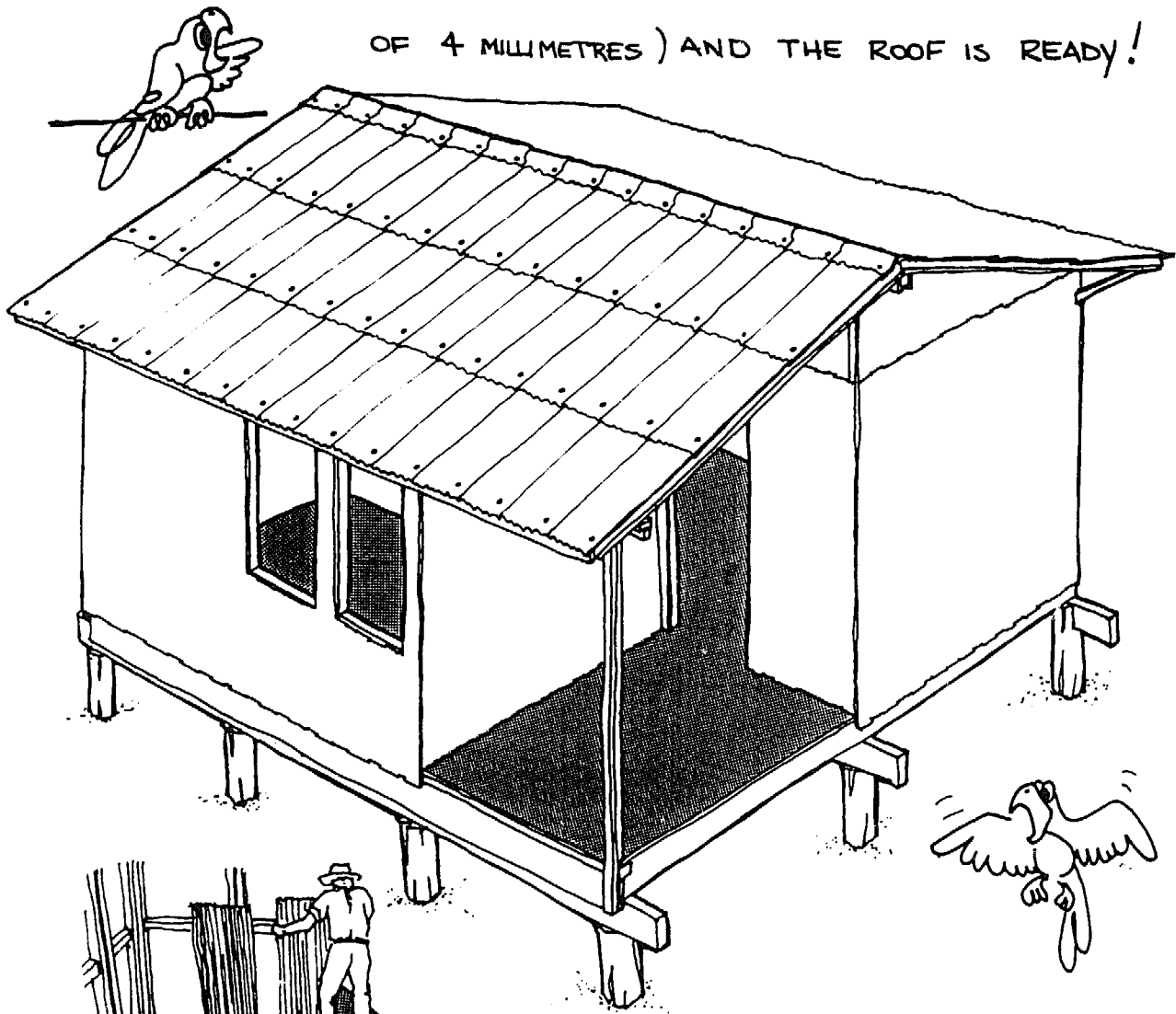

WHEN LAYING ON THE ROOF YOU MUST WALK ON BOARDS VERY CAREFULLY. DON'T FALL AND HURT YOURSELF!

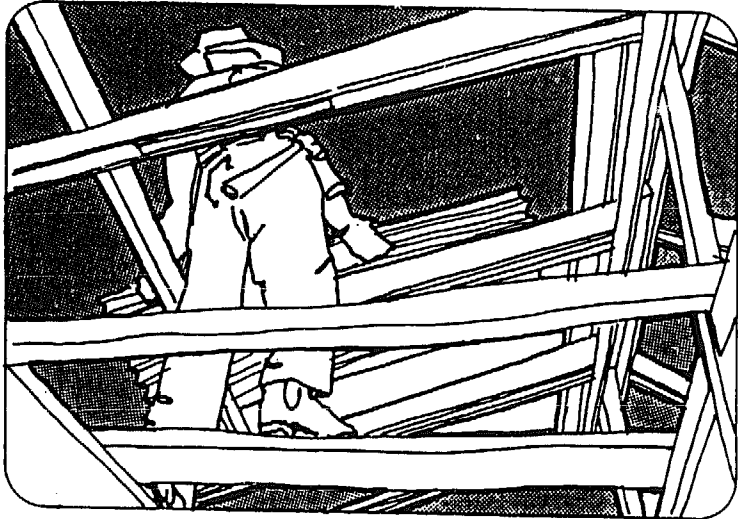

DOORS AND WINDOWS !

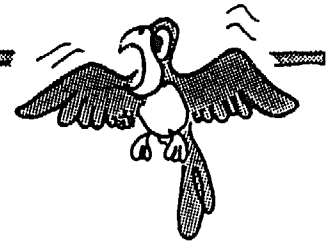

THE DOORS AND WINDOWS CAN BE BOUGHT READY MADE. YOU CAN HAVE THEM MADE TO ORDER OR EVEN MAKE THEM YOURSELF, FOLLOWING THE DRAWINGS AND DIMENSIONS GIVEN BELOW.

USE BOARDS OF 2 OR 2,5 cm THICKNESS AND, IF POSSIBLE, TONGUE AND GROOVE TYPE AND BOARDS OF 2,5 X 10 cm FOR THE CROSS PIECES AND DIAGONAL BRACING.

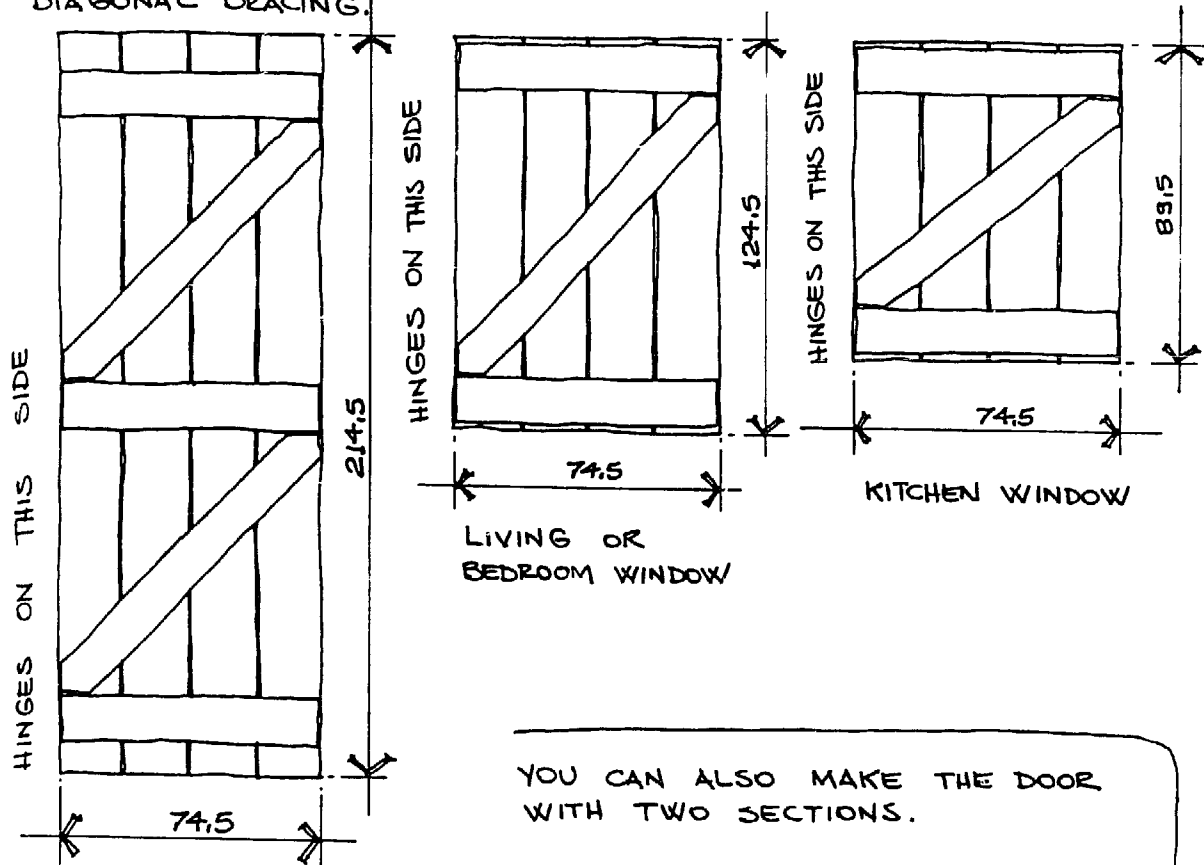

SHOWING INSIDE OF DOOR

YOU CAN ALSO MAKE THE DOOR WITH TWO SECTIONS.

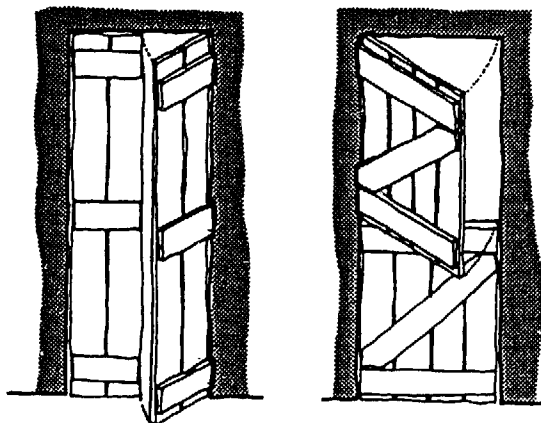

FOLLOW THE DIMENSIONS CORRECTLY !

THE WINDOWS CAN ALSO BE MADE WITH TWO SECTIONS!

RAILING AND STAIRS!

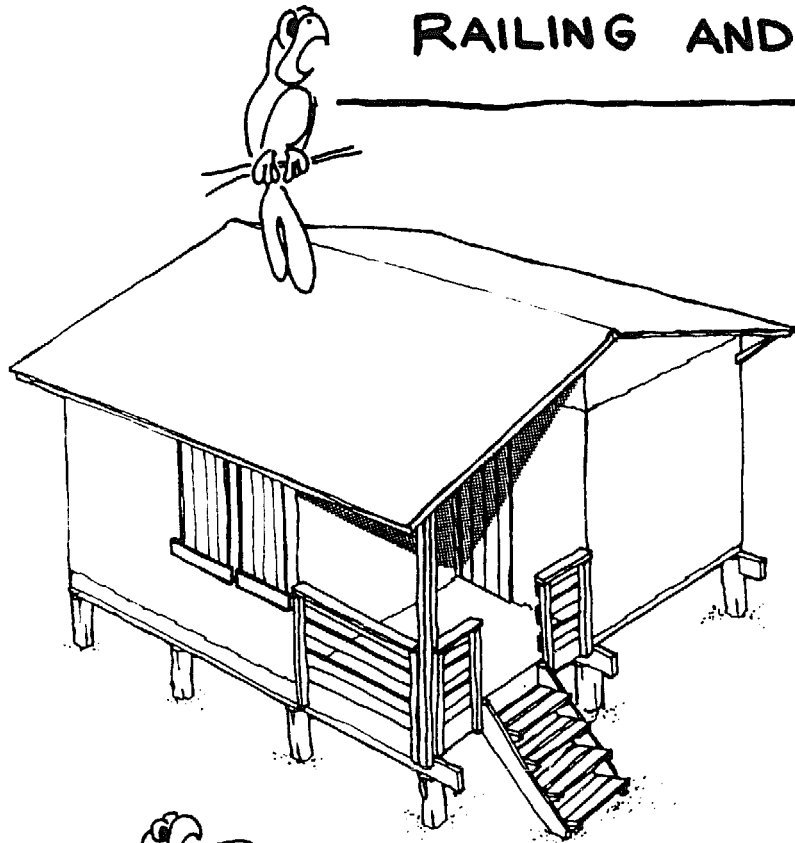

THE RAILING AND THE STAIRS CAN BE DESIGNED AND BUILT BY YOU, TOO. SEE SKETCHES BELOW.

YOU CHOOSE THE POSITION OF THE STAIRS AND ...



THE RAILING IS BUILT WITH 2,5 x 10 cm BOARDS NAILED TO THE RAILING POSTS WITH THREE $l=5$ cm NAILS.

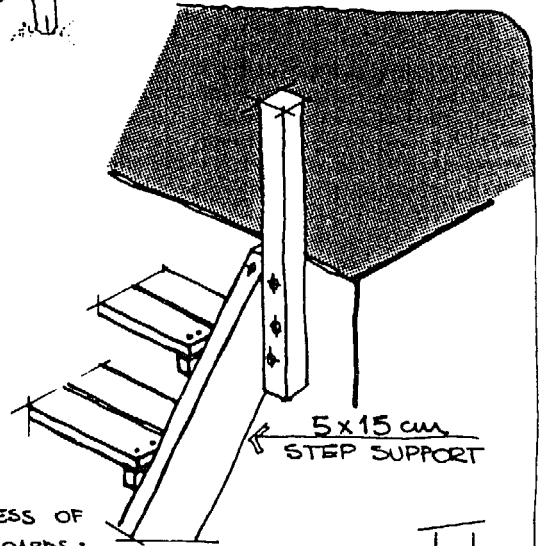

THICKNESS OF STEP BOARDS: 3,5 cm

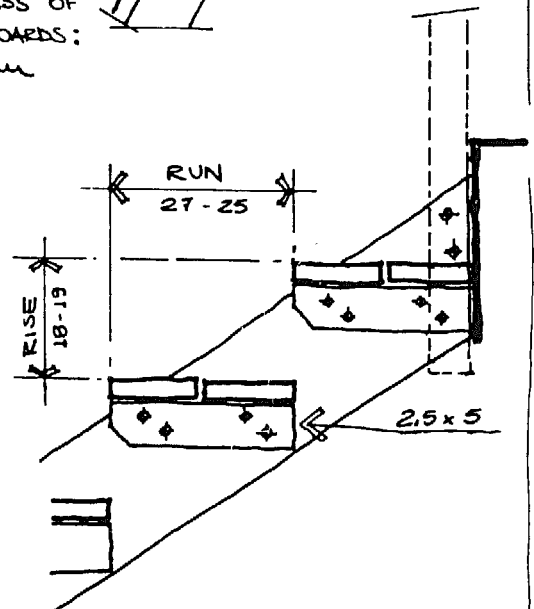
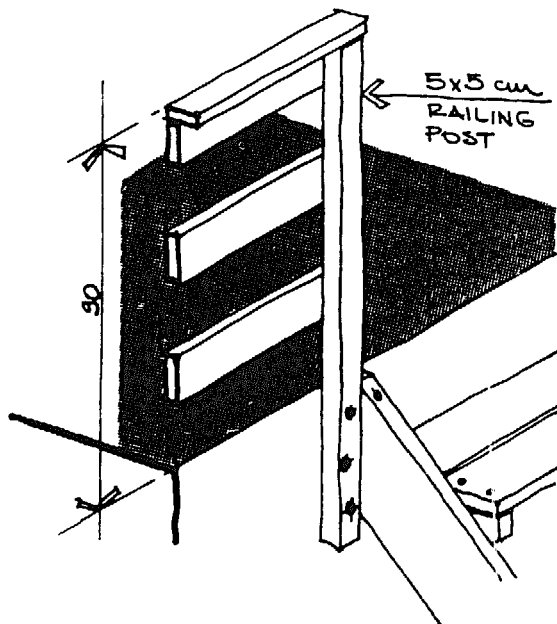

AND FINALLY YOU CAN PAINT
YOUR HOUSE FOR GREATER DUR-
ABILITY BUT, BEFORE PAINTING,
APPLY TWO COATINGS OF A
SUITABLE WOOD PRESERVATIVE.

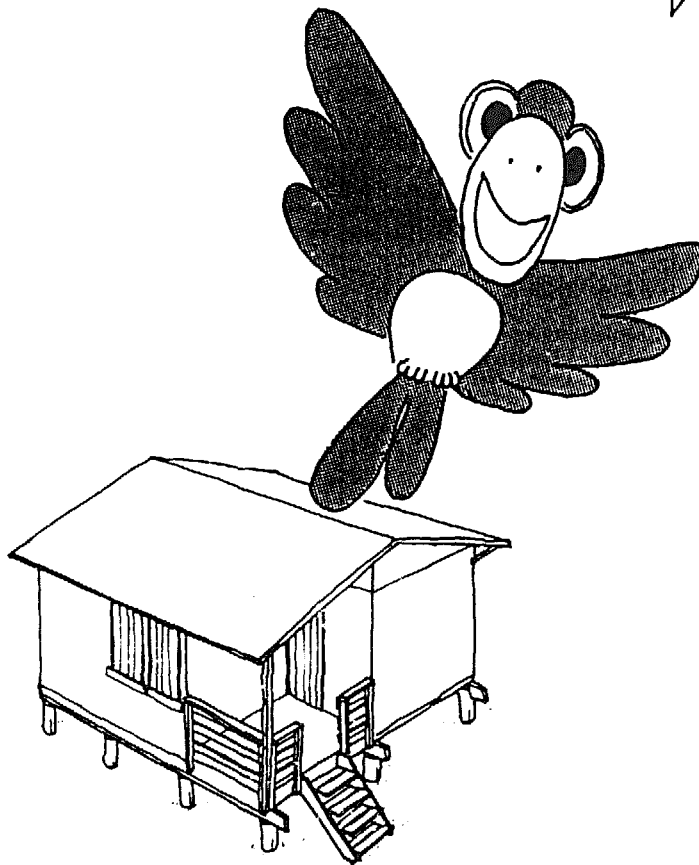

THE MOST SUIT-
 ABLE TYPES OF
 WOOD FOR EACH
 REGION AND EACH
 FUNCTION ARE
 LISTED IN THE
 FOLLOWING TABLE.

3

2

1

PANELS, ROOF FRAME AND FINISHINGS

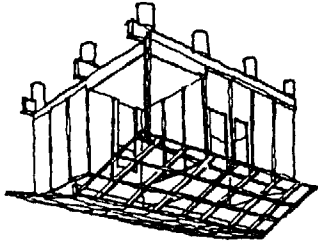

FLOOR FRAME AND PLATFORM

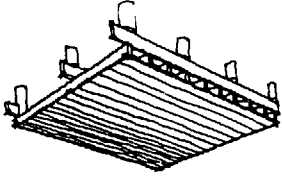

PILES AND MAIN BEAMS

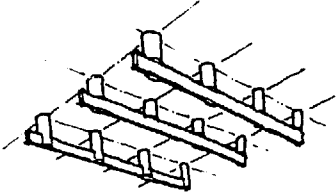

BE CAREFUL WHEN
 CHOOSING THE WOOD SPECIES.
 THE TYPES YOU CHOOSE
 TO MAKE YOUR HOUSE
 WILL DEPEND ON WHETHER
 YOU LIVE IN:

- AFRICA
- ASIA OR
- LATIN AMERICA

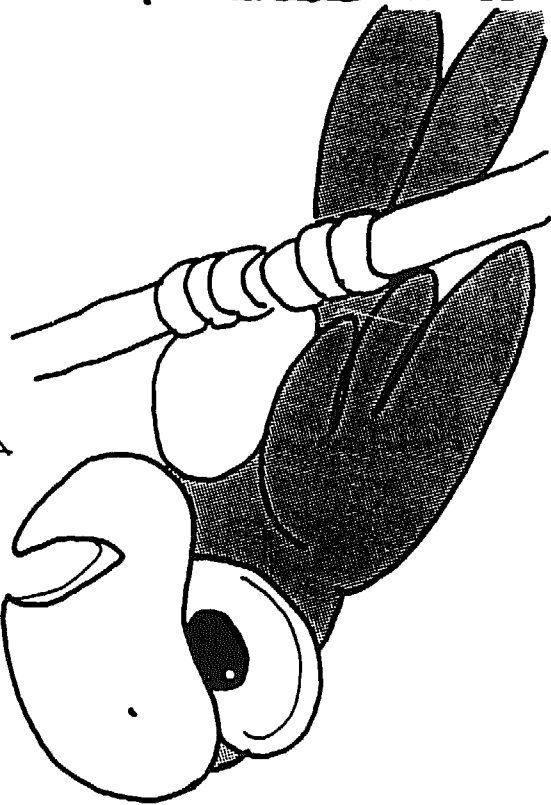

IF YOU CAN'T FIND ANY OF THE WOOD SPECIES DESCRIBED IN THE PRECEDING PAGES IN THE REGION WHERE YOU LIVE, YOU WILL FIND IN THE NEXT TABLES THE INFORMATION THAT WILL HELP YOU TO CHOOSE WITH THE ADVICE OF A TECHNICIAN, THE BEST SPECIES WITH WHICH TO BUILD YOUR HOUSE.

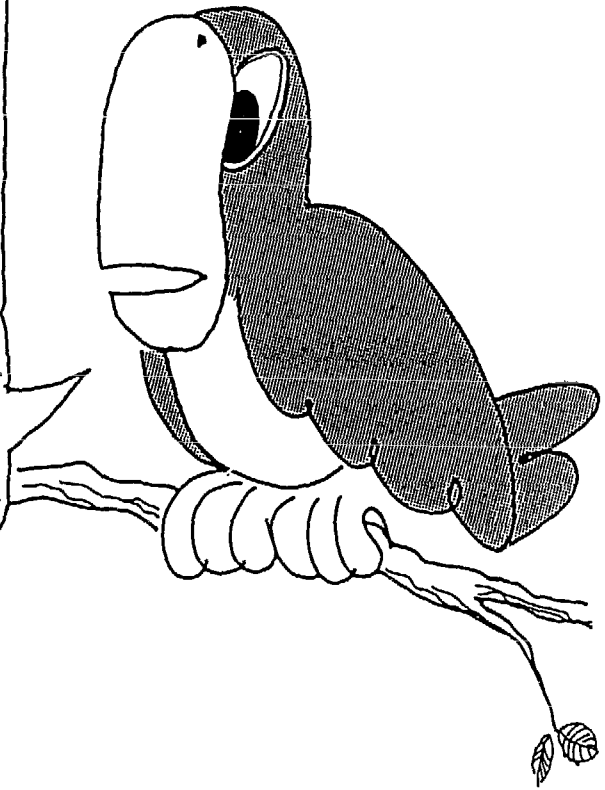

Table 1. Wood species that can be used in wooden house construction

Name and species	Where found	Common local names
AFRICA		
1. <u>Piles and beams</u>		
Afzelia - Afzelia bipindensis (also A. pachyloba, A. africana and A. quanzensis)	West, Middle and East Africa	Lingué (Ivory Coast, Senegal); Papao (Ghana); Apa, Aligna (Nigeria); M'Banga, Doussié (Cameroon); N'Kokongo, Doussié (Angola, Congo); Bolengu (Zaire); Pau Conta (Guinea- Bissau); Mkora, Mbembakft (United Republic of Tanzania); Chanfuta, Mussacossa (Mozambique); Beyo, Meli, Azza (Uganda)
Danta - Nesogordonia papaverifera	East Africa, from Sierra Leone to Cameroon and northern Gabon	Otutu (Nigeria); Kotibé (Ivory Coast); Owóé (Cameroon); Arbor- bora (Gabon); Kondo findo (Zaire); Naouya (Angola); Abumana, Ajumaba, Epro (Ghana).
Ekki - Lophira alata	West Africa	Bongossi, Bakunda (Cameroon); Azobé (West Africa); Kabu (Ghana); Eba, Ekki, Aba (Nigeria); Esoré (Ivory Coast); Endwei (Sierra Leone); Akoga (Gabon); Boukole (Congo)
Opepe - Nauclea diderrichii	From Sierra Leone to the Congo and, in the East to Uganda	Jusia, Kusiaba (Ghana); Badi (Ivory Coast); Bilinga, Akondoc (Cameroon); N'Gou, Masa (Angola, Congo, Zaire); Kilingi (Uganda); Aloma (Equatorial Guinea, Gabon)
2. <u>Floor frame and platform</u>		
Idigbo - Terminalia ivorensis <u>a/</u>	From Guinea to Cameroon	Black afara (Nigeria); Framiré (France, Ivory Coast); Emeri (Ghana)
Guarea - Guarea cedrata G. Thompsonii	Ghana, Ivory Coast, southern Nigeria	Bossé (France, Ivory Coast); Kwabo Koro (Ghana); Obobo (Nigeria), Edoucié (Cameroon)

a/ Only for floors.

Name and species	Where found	Common local names
Makoré - Tieghemella heckelii	From Sierra Leone to Cameroon, Gabon and southern Cabinda	Baku (Ghana); Douka, Ukola (Gabon); Makoré (Ivory Coast)
3. <u>Panels, roof frames and finishings</u>		
Abura - Mitragyna ciliata <u>b/</u>	West Africa, from Sierra Leone to the Congo and Angola	Bahia (Ivory Coast); Subaha, Baya (Ghana); M'Boy (Sierra Leone); M'Boy (Liberia); Elolom (Cameroon); Elelon (Gabon), Vuku, M'Voukou (Zaire); Nzingu (Uganda, Zambia)
Agba - Gossweilerodendron balsamiferum	West Africa, southern Nigeria to the Congo basin	Achi, Egba, Emongi, Ayinre (Nigeria); Tola blanc (Congo); Tola branca (Angola), N'Tola (Zaire)
Limba - Terminalia superba	West Africa, from Sierra Leone to Angola and Zaire	Ofram (Ghana); Akom (Cameroon); Limbo, Chêne-Limbo, Fraké, Noyer du Mayombe, Korina (West Africa); Afara (Nigeria); Limba (Angola, (Zaire); N'ganga (Central African Republic)
Niangon - Tarrietia utilis	From Sierra Leone to Ghana, Cameroon and Gabon	Niankom (Ghana); Ogoué (Cameroon) De-Orh (Liberia); Yawe (Sierra Leone)

ASIA

1. Piles and beams

Kapur - Dryobalanops aromatica, D. lanceolata, D. beccarii	Borneo, Sumatra, Malaysia	Keladan, Kapur (Malaysia); Kapoer (Indonesia); Kapor (Sabah)
Kempas - Koompassia malaccensis	Malaysia, Sumatra, Borneo, Indonesia	Impas (Sabah); Mengaris (Sarawak)
Keruing - Dipterocarpus Spp	Indo-Malaysian region	Keruing (Indonesia, Malaysia, Sabah, Sarawak); Gurjun (Burma, India); Yang (Thailand), Apitong (Philippines); Eng Or In (Burma); (Langan, Keroeing (Indonesia); Dau (Democratic Kampuchea, Viet Nam)

b/ A preservation treatment is advisable.

Name and species	Where found	Common local names
Merbau - <i>Intsia palembanica</i> , <i>I. bijuga</i>	Indo-Malaysian region, Indonesia, Philippines Australia and western Pacific Islands	Tat-Talum (Burma); Lumpha, Lumpho (Thailand); Kwila (New Guinea); Vesi (Fiji Islands); Ipil (Philippines); Merbau (Malaysia)
2. <u>Floor frame and platform</u>		
Dark red meranti - <i>Shorea</i> Spp	Peninsular Malasia, Sabah and Sarawak, Indonesia and Philippines	Saya (Thailand); Red seraya (Malaysia); Meranti, Merah (Indonesia); White lauan, Almon, Mayapis (Philippines)
Kohko - <i>Albizia lebbek</i>	South and South-East Asia, Burma, India, Indo-China, Malaysia and the Philippines	Siris, Siris tree, East Indian walnut
Mengkulang - <i>Heritiera simplicifolia</i>	India, from Malaysia to Indonesia, Philippines and other Pacific islands	Kembang (Malaysia); Kanze (Burma); Chuprak (Thailand); Lumsayan, Lumbayau (Philippines); Huynh (Democratic Kampuchea)
Ramin - <i>Gonystylus bancanus</i> <u>b/</u>	Malaysia, Indonesia and Philippines	Melawis (Malaysia); Garu-Buaja (Indonesia); Janutan-Bagio
3. <u>Panels, roof frame and finishings</u>		
Geronggang - <i>Cratoxylon arborescens</i> <u>b/</u>	South-East Asia, Malaysia, Indonesia, Brunei	Serungan (Sabah, Sarawak, Brunei Darussalam)
Krabak - <i>Anisoptera</i> Spp	Burma, Indonesia, Malaysia, New Guinea, Philippines, Thailand	Mersawa (Brunei Darussalam, Malaysia); Kanghmu Palosapis (Philippines); Phdiek (Democratic Kampuchea); Ven-Ven (Viet Nam)
Light red meranti - <i>Shorea</i> Spp	Indonesia, Malaysia and Philippines	Light red seraya, red seraya (Malaysia); Saya (Thailand); Meranti merah (Indonesia); White lauan, Almon, Mayapis (Philippines)
White seraya - <i>Parashorea plicata</i>	Brunei Darussalam, Malaysia and Philippines	Bagtikan (Philippines); Urak Mata (Malaysia)

Name and species	Where found	Common local names
LATIN AMERICA		
1. <u>Piles and beams</u>		
Balata - <i>Manilkara bidentata</i>	West Indies, Central America and northern part of South America	Chicozapote (Mexico); Ausubo (Puerto Rico, Dominican Republic); Nispero (Panama); Beefwood (Guyana); Bolletri (Suriname); Balate rouge (French Guyana); Maçaranduba (Brazil)
Courbaril - <i>Hymenaea courbaril</i>	South of Mexico, Central America, West Indies, Bolivia, northern part of Brazil and Peru	Cuapinol, Guapinol (Mexico); Guapinol (Central America); Locust, Kawanari (Guyana); Rode lokus (Suriname); Algarrobol (Spanish-speaking Latin America); Jutai, Jatobá, Jatai (Brazil)
Manbarklak - <i>Eschweilera longipes</i>	Amazon basin, Costa Rica, Guyanas and Trinidad	Oxito, Olleto (Panama); Coco de mono, Moutangero (Venezuela); Coco cristal, Tete congo (Colombia); Haudan, Kakeralli (Guyana)
Tonka - <i>Dipteryx odorata</i>	Brazilian Amazon Region, Colombia, Guyanas and Venezuela	Almendro (Costa Rica, Panama); Serrapia (Colombia, Venezuela); Cumarú (Brazil); Charapilla, Cumarut (Peru)
Wallaba - <i>Eperua bijuga</i>	Brazilian Amazon region, Guyanas and Venezuela	Palo machete (Venezuela); Wallaba, Bijlhout (Suriname); Wapa (French Guyana); Apá, Apazeiro, Jébaro (Brazil)
2. <u>Floor frame and platform</u>		
Angelin - <i>Andira inermis</i>	From south of Mexico through Central America and northern part of South America (Brazil and Peru). Also occurs in Guyana and Trinidad	Moca (Cuba, Puerto Rico); Cuilimbuco, Maquilla (Mexico); Barbosquillo, Arenillo (Panama); Rodes kabbes (Suriname); Acapurana (Brazil)
Gronfoloe - <i>Qualea albiflora</i>	Tropical America, from south of Mexico to Peru. Abundant in Brazil and Guyanas	Florencillo (Venezuela); Kouali, Gringnongou (French Guyana); Gronfoloe (Suriname); Quaruba, Mandioqueira (Brazil)

Name and species	Where found	Common local names
Kopie - <i>Goupia glabra</i>	Amazon, Colombia and Guyana	Saino, Sapino (Colombia); Kopi (Suriname); Kabukalli (Guyana); Groupie (French Guyana); Cupiúba (Brazil)
Mahoe - <i>Hibiscus elatus</i>	Brazil, Cuba, Jamaica, Mexico, Peru and West Indies	Emajagua excelsa (Puerto Rico); Majagua, Majagua azul (Cuba); Mountain mahoe (Jamaica)
Manni - <i>Symphonia globulifera</i>	West Indies, Central America and northern part of South America	Barillo (Guatemala, Honduras); Cerillo (Costa Rica, Panama); Machare (Colombia); Mani, Paramán (Venezuela); Matalci (Suriname); Manni (Guyana); Breacaspi (Peru); Anani (Brazil)
Nargusta - <i>Terminallia amazonia</i>	From south of Mexico to Central America and northern part of South America. Also occurs in Guyana and West Indies	Almendro (Honduras); Canshán (Mexico); Amarillo carabazuelo (Panama); Guayabo león (Colombia); Pardillo negro (Venezuela); Pau, Mulato branco (Brazil)

3. Panels, roof frame and finishing

Determa - <i>Ocotea rubra</i>	Brazil's lower Amazon region, Guyana and Trinidad	Louro vermelho (Brazil); Determa (Guyana); Wana, Wane (Suriname); Grignon rouge (French Guyana)
Crabwood - <i>Carapa guianensis</i>	West Indies, from Cuba to Trinidad, from south Honduras, through Central America to Guyanas and Brazil, Colombia and Peru and high countries of the Orinoco in Venezuela	Cedro-macho (Venezuela); Kapra (Suriname); Figueiro, Tangaré (Ecuador); Andiroba (Brazil, Peru)
Santa Maria - <i>Calophyllum brasiliense</i>	West Indies and from south of Mexico, through Central America to northern part of South America	Bari, Leche de Maria (Mexico); Calaba (Panama); Aceite Maria (Colombia); Edaballi kurahara (Guyana); Balsa Maria (Bolivia); Guanandi, Jacareuba (Brazil)
Roble - <i>Tabebuia rosea</i> , <i>T. heterophylla</i>	West Indies, south of Mexico to Ecuador and Venezuela	Roble (Spanish-speaking Latin America); Amapa, Roble blanco (Mexico); Roble blanco, Roble de sabana (Costa Rica); Roble del rio (Colombia); Apamate (Venezuela)

Table 2. Characteristics of woods from Acariquara (Minuartia guianensis) and Jacareuba (Calophyllum brasiliense)

Properties	Acariquara	Jacareuba
Specific mass (density) at 12% humidity	912 kg/m ²	624 kg/m ²
Volumetric shrinkage, green-dry	14%	12.3%
Static bending strength at 12% humidity		
- Rupture modulus (MOR)	135 MPa	101 MPa
- Elastic modulus (MOE)	16,840 MPa	12,630 MPa
Compression strength along the grain at 12% humidity, maximum strength	69 MPa	48 MPa
Natural durability for fungus and termite attack	Very durable	Moderately durable
Preservability	Not treatable	Sapwood treatable; heartwood not treatable
Easiness of mechanical fixing	Regular	Good
Other observations	Difficult to work	Tendency to split and to warp

Source: Tropical Woods, No. 94 (1954) and No. 103 (1955).

Note: You can compare the characteristics of these types of wood with those of wood found in your area.

Table 3. Requisites for each type of use

Use	Requisites
Piles	High specific mass 700 kg/m ³
Beams	High to very high mechanical properties: Bending strength Rupture modulus 121 MPa Elastic modulus 15,000 MPa Parallel compression maximum strength 56 MPa Durability: high, resistant to more than 12 years in contact with ground Preservability: easy; permeable Mechanical fixation: easy
Floor frame	Medium to high specific mass 500 kg/m ³ Medium to very high mechanical properties: Bending strength Rupture modulus 86 MPa Elastic modulus 12,000 MPa Parallel compression maximum strength 56 MPa Durability: high, resistant to more than 12 years in contact with ground Preservability: easy/permeable Mechanical fixation: easy
Joists, windows and doors, joists' header boards, inter-panel finishing boards, inter-panel studs, facias, purlins, beams, rafters and posts	Medium to low specific mass 700 kg/m ³ Volumetric shrinkage (percentage of the dimension of green wood): 13.5 % Medium mechanical properties Bending strength Rupture modulus 86 MPa Elastic modulus 12,000 MPa

Use

Requisites

than

Durability: high, resistant to more

12 years in contact with ground

Preservability: easy/permeable

Mechanical fixation: easy

Workability: moderate to very easy

Source : Grupamento de Madeira da Amazônia por similaridade de características e usos (Sudam, Instituto de Pesquisas Tecnológicas, 1981).

