

AT MICROFICHE
REFERENCE
LIBRARY

A project of Volunteers in Asia

Water Power for the Farm
Bulletin No. 197

by: O.W. Monson and Armin J. Hill

Published by:
Montana Agricultural Experiment Station
Montana State University
Bozeman, MT 59717 USA

Paper copies are \$ 4.15.

Available from:
Montana Agricultural Experiment Station
Montana State University
Bozeman, MT 59717 USA

Reproduced by permission of Montana Agricultural
Experiment Station, Montana State University.

Reproduction of this microfiche document in any
form is subject to the same restrictions as those
of the original document.

WATER POWER FOR THE FARM

by

O. W. MONSON

Irrigation Engineer

and

ARMIN J. HILL

Rural Electrical Engineer

MONTANA AGRICULTURAL EXPERIMENT STATION

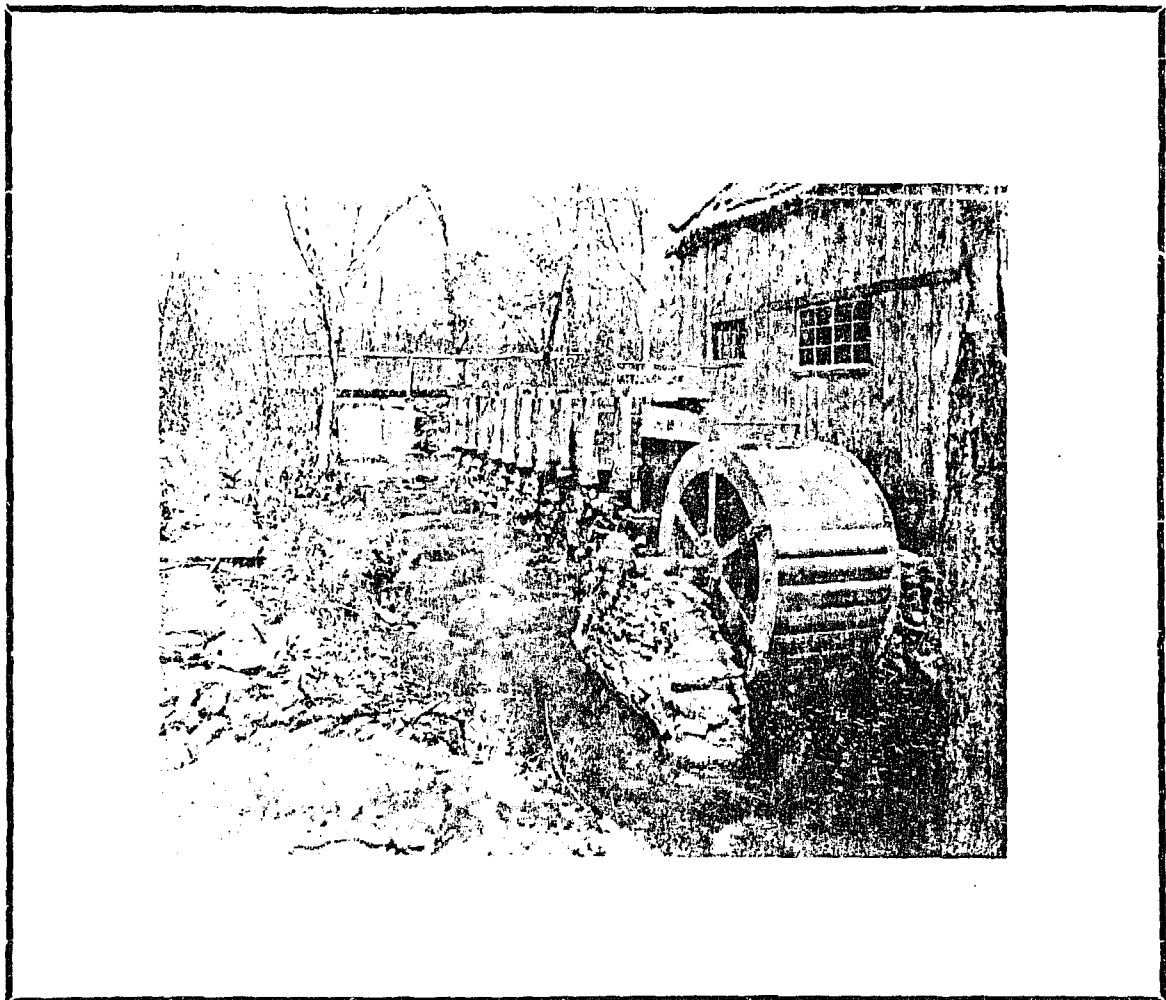

Montana Extension Service in Agricultural and Home Economics, J. C. Taylor director.
Montana State College and United States Department of Agriculture cooperating.
Distributed in furtherance of the Act of Congress, May 8 and June 30, 1914

TABLE OF CONTENTS

	Page
INTRODUCTION	1
PART I. PLANNING A SMALL WATER POWER PLANT	2
The Preliminary Survey	3
Determining the Power Available	3
Planning for Use of Power	6
Considerations in Estimating the Cost of a Water Power Installation	6
Location of the Power Site	9
Selecting the Type of Water Wheel	9
Current Wheels	9
Overshot Wheels	10
Turbines	12
Impulse Wheels	12
Methods of Power Transmission	13
Survey and Design Data for Complete Plant	15
Checking Finished Plans	15
PART II. DAMS AND WATER CONTROLS	17
PART III. CONSTRUCTION AND INSTALLATION OF HYDRO-ELECTRIC PLANTS	20
Size of Generating Plant Required	20
Details of Hydro-Electric Plants	23
The Generator	23
The Switchboard	24
The Battery	24
Transmission Lines	25
Entrances to Buildings	27
Types of Wiring	27
Outlets and Switches	29
Protection of Electrical Equipment	29
APPENDIX I. SOME DEFINITIONS	i
APPENDIX II. DETERMINATION OF AVAILABLE POWER	iv
APPENDIX III. ENERGY AND POWER LOSSES	vii
APPENDIX IV. SIZES OF ELECTRICAL CONDUCTORS	viii

Issued jointly by the Montana Agricultural Experiment Station
and the Montana Extension Service
Bozeman, Montana

LIST OF ILLUSTRATIONS

	Page
An Overshot Water Wheel (Courtesy Campbell Water Wheel Company)	Cover
Figure 1. Measurement of Head	5
Figure 2. Measuring Velocity of A Stream	5
Figure 3. A Turbine Installed in An Open Flume	7
Figure 4. A Current Wheel with Buckets for Lifting Water	11
Figure 5. An Impulse Wheel	11
Figure 6. A Developed Power Site Showing Relationship of Various Parts of A Hydro-Electric Installation	16
Figure 7. A House Wiring Plan	16
Figure 8. Construction of Dams, Flumes, and Headgates	18
Figure 9. Two Ways of Storing Energy	21
Figure 10. Uses of Energy from A Plant of Less Than 1 Kilowatt Capacity	21
Figure 11. Additional Uses of Energy from A Plant of from 1 to 3 Kilowatts Capacity	21
Figure 12. Additional Uses of Energy from A 4 to 5 Kilowatt Plant	22
Figure 13. Details of Transmission Line Construction	26
Figure 14. Details of Entrance to A Residence	26
Figure 15. Open Knob and Tube Wiring in A Barn (Courtesy University of Minnesota)	28
Figure 16. Armored Cable Wiring in A Granary (Courtesy University of Minnesota)	28
Figure 17. Non-Metallic Sheathed Cable in A Dairy Barn (Courtesy University of Minnesota)	28
Figure 18. A Definition of Work	ii
Figure 19. Three Forms of Energy	ii

WATER POWER FOR THE FARM

Amin J. Hill and W. Hanson
Department of Irrigation and Drainage

INTRODUCTION

The fast flowing mountain streams, creeks, and rivers, found in most sections of Montana, provide numerous opportunities for the installation of small water power plants. Attempts have been made to develop many of these power sites, but for one reason or another many have been abandoned. With increasing use of gasoline and electric power, however, there is an increased interest in these sources of power supply, particularly in those localities where the building of electric power lines will not be practical.

Small water power installations, when properly developed, can be very satisfactory, and many have given good service for long periods of time. Such installations are real assets, and well worth the necessary time, effort, and expense. However, the design and installation of a successful plant is not always an easy task. If it is not carefully planned it cannot be expected to give satisfactory results. If makeshift equipment is used, or if equipment is improperly or carelessly installed, there is a good possibility that the development will be a disappointment, if not a complete failure. Most of the plants which have been only partially successful, or which have been abandoned entirely, have had one or more of the following faults: (1) the water power available in the stream was not sufficient; (2) the plant wasted too much of the available power; (3) power was not dependable because (a) the water supply became inadequate during low water seasons, or (b) because the plant did not operate satisfactorily; (4) the equipment wore out before it had paid for itself; or (5) the equipment was damaged or put out of commission by floods or other unusual conditions.

A careful preliminary survey is necessary to determine whether or not the plant will develop enough power to be economically worth while. A comparison with other forms of power supply must be made in order that the least expensive kind will be secured. Complete plans and designs for all parts of the plant and connected equipment should be made and checked carefully before any installation is undertaken or very much money or time is invested. In this way satisfactory results from any effort or investment will be assured. Careful design and installation will keep power losses at a minimum, and make the development as useful as possible. The cost of equipment, which is usually one of the major expense items, can be kept down by: (1) judicious use of homemade (but not makeshift) equipment; (2) proper selection of power site, type of equipment used, method of power transmission, etc.; and (3) effective use of favorable natural conditions.

Information given here is intended to be helpful in the proper design, selection, and installation of small water power equipment. Directions and specifications are included for the construction of some types of dams and water controls which are practical for use with water power plants. Information is also included on the installation of small hydro-electric plants, as these provide one of the best methods of harnessing water power for general farm use. It is hoped that this information will assist in the

rehabilitation of many power sites now abandoned or not operating satisfactorily, and that it will also help in the development of new sites in these locations where such development is economically practicable.

PART I.

PLANNING A SMALL WATER POWER PLANT

The importance of carefully made, complete preliminary plans cannot be over-emphasized. All factors must be given proper consideration if the installation is to be successful. Many of these factors are technical in nature, and therefore, if possible, it is well to consult an engineer or other person experienced in the installation of water power equipment. Manufacturers of water power equipment often have engineers available, and are usually willing to give as much assistance as they can. Other reliable sources of information and help should also be used to the fullest extent.

Planning is best done in two steps. First, a preliminary survey should be made to determine the feasibility of the project. This survey should answer the following questions:

1. How much water power is available? Is there enough to make a development worth while? Will it be dependable or will it be necessary to provide for daily or seasonal fluctuations of supply or of demand for the power? How will very dry seasons affect these considerations?
2. How much power is needed? Will the water available satisfy the power demands of the farmstead, or will it be necessary to have auxiliary power for part or all of the time? How can the power be used so that it will be of greatest service?
3. Will the expense of the installation be worth while? Will construction of the plant provide a worth while way of using "spare" time? Can power be secured more cheaply in some other manner. Is there a probability that this installation will repay the investment in materials and labor, and do so within a reasonable period of time?

Second, if the results of this survey show that the project is feasible, detailed designs and plans should be made as follows:

1. Survey the site, locating power house, dams, canals, tailrace, etc.
2. Select the type of water wheel which will be the most satisfactory.
3. Decide on the most suitable method of power transmission.
4. Design the dam, the wheel and the power house, draw a diagram of all electric transmission and building wiring, or if direct drive is used, sketch the arrangement of all driven equipment, line shafts, belts, gears, etc. Plan all other pertinent details carefully and make an estimate of the total cost.

- 5. Check all plans to see that no error has been made. If the project looks good "on paper", a real start will have been made toward securing a satisfactory installation.

The Preliminary Survey

Determining the Power Available:

The amount of power available for development depends upon two factors: (1) the "head", which is the total amount of fall available (usually measured in feet), and (2) the normal rate of flow, which is usually measured in cubic feet per second ("second-foot"). A rate of flow of one second-foot with a head of ten feet will theoretically develop approximately one horsepower.* This gives a rule of thumb method for making a quick estimate of the power available: multiply the rate of flow in second feet by the net available free fall or head in feet, and divide by 10 to obtain roughly the theoretical horsepower. The amount of power which can actually be developed will be from one-third to three-fourths this value, depending upon the efficiency of equipment used. If the velocity of the stream in feet per second is known, the equivalent head in feet can be found from table 3 in appendix II.

In case the available power is desired in terms of kilowatts instead of horsepower, one horsepower is equal to approximately three-fourths of a kilowatt. Therefore, theoretical power available in kilowatts is about three-fourths that in terms of horsepower. Since some power will be lost in generation of electrical energy (which is usually considered when the term "kilowatt" is used), the number of kilowatts available from a development can usually be taken at about half the number of horsepower determined according to the above rules.

Tables for making closer estimates of the power which can be delivered in useful form, when the head and rate of flow are known, are given in appendix II. In case this power will be inadequate, an increase in the amount of power available may be obtained by: (1) creating a pond which will store water through periods of light power demand to supply additional flow when the demand is heavy, (2) increasing the head by (a) building a higher dam, or (b) by diverting water farther upstream, and (3) decreasing losses and wasted water by more careful design and construction of canals, flumes, and other equipment. One or more of these methods must be used to improve or rehabilitate existing power plants in order to increase their output.

*Actually the theoretical power available from ten feet-second-foot is 1.135 horsepower. However, since the amount which will be lost in development is very hard to estimate, this rule of thumb is close enough for this purpose. In case the flow in Montana minor's inches is known, this should be divided by 40 to obtain the flow in second-foot.

Before the head can be estimated it is necessary to determine the probable location of the power plant, to decide what kind of dam which will be used, and to select its approximate location. It may be possible to secure an ample flow of water by means of a simple diversion dam some distance upstream. This will necessitate a long canal in most cases, and may require expensive fluming. Instead of this arrangement, it may be possible to have a higher dam near the plant. A dam of this type will be more expensive than a diversion dam, but less canal and flume will be necessary. Also, there will be the advantage of having a pond which will make possible better control of the flow of water to the plant. This often makes possible, in turn, the use of larger capacity equipment, and the pond may help materially during periods of low water flow.

In considering a storage pond, it is usually not wise to provide for more than daily or weekly fluctuations in water level. Seasonal storage will require a more expensive dam and a larger storage area. These may be valuable for other than power purposes, however.

After the water level at the dam has been determined, the point downstream where the plant probably will be located should be decided upon. The vertical distance between the surface of the water back of the dam, and the surface of the stream at the plant site will be the total head available (see figure 1). An engineer's level, or for short horizontal distances a carpenter's level, can be used to determine this height.

If a velocity meter is not available, the velocity of a stream can be estimated by measuring a fixed distance of any length from 50 to 200 feet along a portion of the stream where the bed is of uniform depth and grade (see figure 2). Opposite the upper mark, throw in a handful of chips or leaves. Determine as accurately as possible--using a stop watch if one is available--the length of time it takes until the center of this cluster of chips or leaves passes the lower mark. Determine this several times, and then take the average. Use four-fifths of this average value to obtain the approximate velocity of moderately sized streams (usually calculated in terms of feet per second).

The rate of flow should be determined for all seasons of the year. It is particularly important that the least flow which ordinarily can be expected be determined, for this will become a limiting factor in planning uses to which the power will be put. This low flow must provide sufficient power to operate any equipment which may be used at that season of year during which it occurs. Otherwise an auxiliary power supply will be necessary. Possible flood conditions should also be anticipated and considered so that provision can be made to prevent damage to the plant during flood seasons. If a pond or other storage reservoir is to be used, it will be well to know also the total run-off for the year. Often it may be desirable to make a survey of the entire drainage basin of the stream to make sure that sufficient water will be available. Too much stress cannot be given this important point, for one of the primary causes of disappointment with small water power plants is their failure to provide adequate power throughout the year.

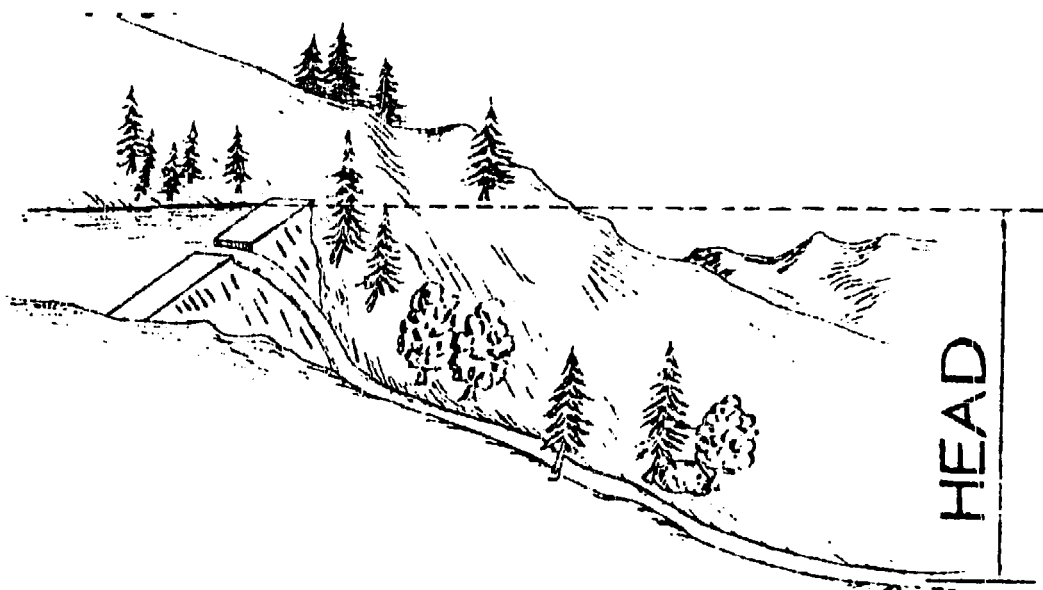

FIGURE 1. MEASUREMENT OF HEAD

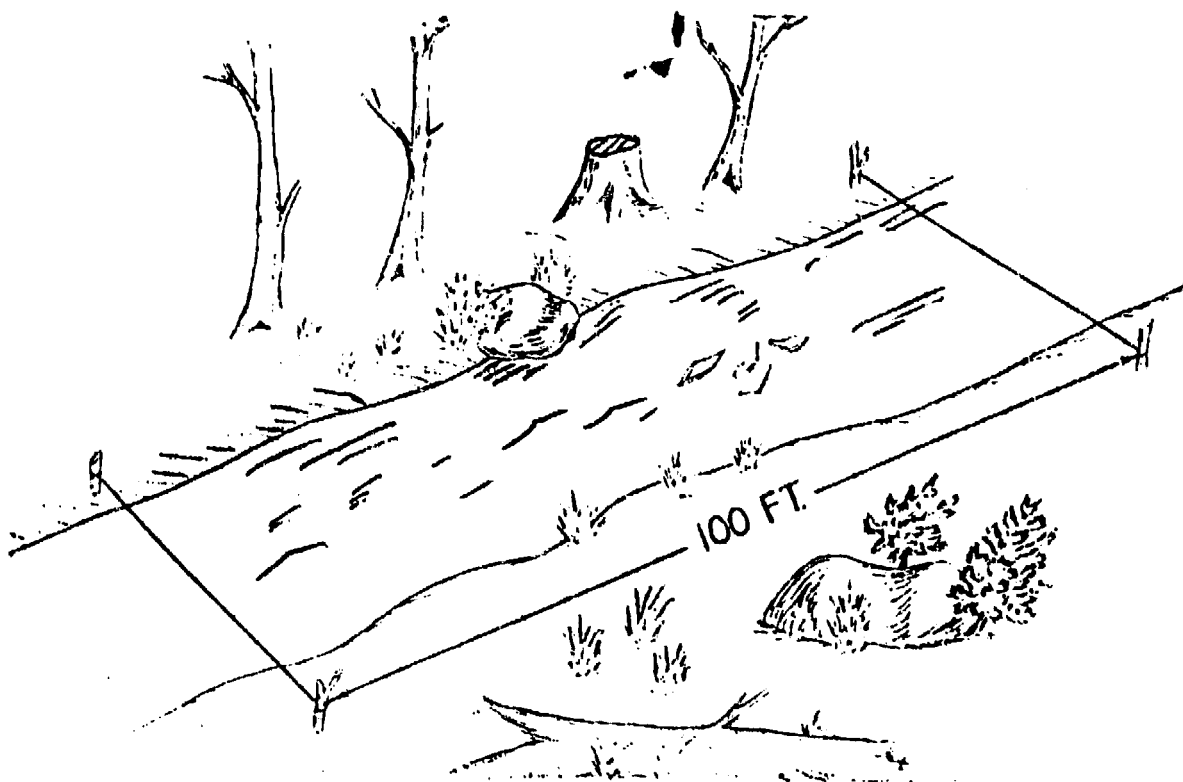

FIGURE 2. MEASURING VELOCITY OF A STREAM

The most satisfactory method to obtain this data is to install some form of a weir in the stream. This will make possible the taking of readings over a long period of time, and such readings are essential if complete information on the stream flow is to be secured. If only a rough estimate of the flow is desired, however, and the velocity at any point is known, it is merely necessary to determine the cross-sectional area of the stream at that point. If this is found in square feet, and multiplied by the velocity in feet per second, the rate of flow in second-feet is determined. Cross-sectional area can be found by taking several measurements of the depth of the stream at uniformly spaced points across the stream, averaging these, and multiplying by the width of the stream at that point.

Planning for Use of Power:

If a power plant is to be successful, it must be able to supply power for some useful purpose around the farmstead. Often a definite power demand exists before the plant is considered, and it is important to know beforehand that the proposed plant can meet this demand satisfactorily. Also, as soon as power is available, additional demands may be made on it, and the most satisfactory plant will be the one which can meet not only present, but future demands as well. In any case, the limitations of a proposed plant should be known before any investment is made. Only in this way can results be satisfactory. For these reasons it is very important that the uses to which the available power is to be put be carefully planned in advance. Some contemplated uses may have to be abandoned. Provision may have to be made to secure additional power, or means may have to be provided to supply auxiliary power. All of these factors should be considered before the plant is built, rather than afterward, for in this way a well balanced farm power unit can be developed.

Water power installations, from the very smallest to the largest, can be used for pumping water for the household or for irrigation. Very small water wheels can drive small direct connected pumps to deliver necessary water for household use, while large irrigation pumps require several horsepower, or even several hundred in some cases. Wheels which will deliver less than one-half horsepower will not be very practical except for driving small water pumps, grindstones, small mills, or they may be connected to drive a small generator, and in conjunction with a storage battery furnish a few lights and power for a radio. Larger power outputs can readily be put to many types of uses around the farmstead, particularly when electrical transmission is used to deliver the power where it can be used the most conveniently (see figures 10, 11 and 12).

Considerations in Estimating the Cost of a Water Power Installation:

Each development has so many individual problems and conditions that it is necessary to have plans for a specific project fairly complete before any estimate of probable cost can be made. A rough preliminary estimate should be made, however, in order that the feasibility of the project can be determined before too much time is spent on the final plans. Costs of individual items, and of the total installation, may vary between wide limits for different installations, depending on:

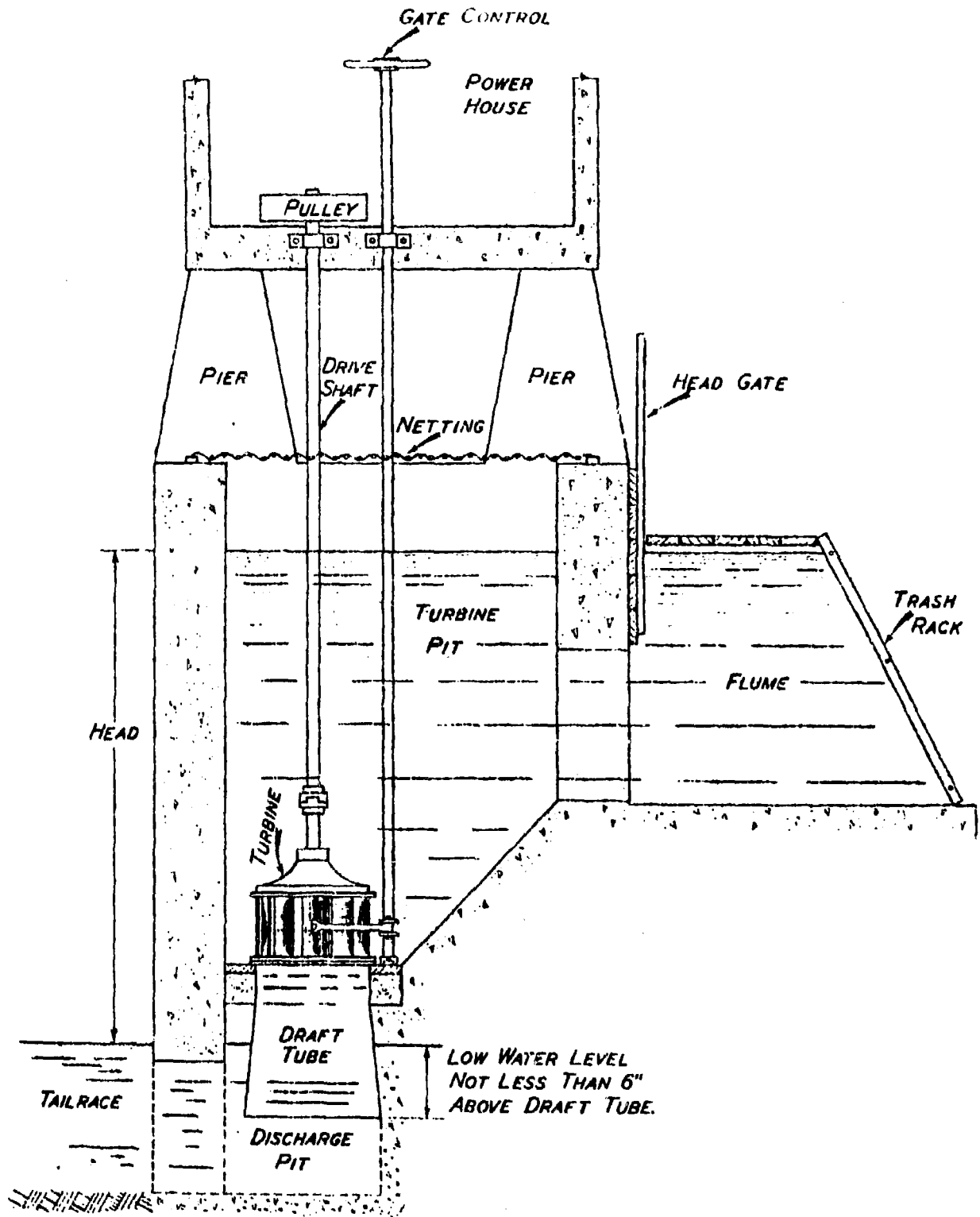

FIGURE 3. A TURBINE INSTALLED IN AN OPEN FLUME

1. Whether commercial or homemade equipment is used.
2. Whether or not spare time labor is available. (A project of this nature may provide a valuable use for spare time.)
3. Available head, type of dam, preparation necessary for storage area, length of canal required, type of water wheel or turbine which will be necessary, method of power transmission to be used, distance of power site from farm buildings, and related factors.
4. Construction difficulties, cost of materials, and related factors.

There is usually a tendency to overlook or neglect important costs in connection with small water power plants. Any of the following items may enter into the cost of a complete installation, and should be given proper consideration:

1. Dam, spillway, headgates, etc.
2. Canal, flumes, penstock, etc.
3. Control valves or gates, weed rack, etc.
4. Tailrace.
5. Water wheel or turbine, with suitable mounting, bearings, etc.
6. Governor.
7. Gearing, pulleys, or other speed changing mechanism.
8. Generator, line shaft, or other means of power transmission. If electrical transmission is used there may be the following to consider.
 - a. Battery, switchboard, meters, regulator, transmission line to buildings, poles, cross-arms, insulators, line wire, guy wires, anchors, grounds, etc.
 - b. Wiring in houses and outbuildings.
 - c. Meters, electric appliances, and lighting fixtures.
9. Driven equipment such as pumps, grinders, mills, etc.
10. A suitable building to house the water wheel, and generating or transmission equipment.

Location of the Power Site

In making the preliminary survey, a probable location for the power site has been selected. If the preliminary considerations have indicated that the project will be worth while, a final survey and design of the power plant should be undertaken. The site should be located at the point where the available head for a given horizontal distance will be the greatest. Penstocks, flumes, or canals should be as direct and short as possible. Also the method of power transmission to be used must be kept in mind. A direct-driven pump must, of course, have the wheel near the source of water which will be pumped. Direct drives to farm equipment will be possible only if the wheel can be located very near the farm buildings. If electrical transmission is used, larger wire and higher voltages will be required to transmit power any distance. Thus if a site with a satisfactory head can be located near the farm buildings, this should be done. Otherwise, the cost of a canal, etc., must be balanced against the cost of additional transmission line until an arrangement is found where the total cost will be at a minimum.

Selecting the Type of Water Wheel

Power can be developed from low heads if a large quantity of water is available. The higher the head, the smaller the flow required, and in general the less expensive the equipment for a given power output. With different heads and rates of flow, different types of wheels are needed. The four general types which have been found to be practical for small power installations are: (1) the undershot, or current wheel; (2) the overshot wheel; (3) the turbine; and (4) the impulse (Pelton) wheel. Wheels are designed to operate under heads and with speeds which approximate those indicated below:

Total head	Type of wheel	Speed in R.F.M.*
0.5 ft. to 4 ft.	Current wheel	0.2 to 20 rpm
3 ft. to 30 ft.	Overshot wheel	5 to 40 rpm
3 ft. to 80 ft.	Turbines	100 to 3000 rpm
15 ft. to 1000 ft.	Impulse wheel	100 to 3500 rpm

*Revolutions per minute

Current Wheels (see figure 4):

These wheels can be operated with very low heads. They are fairly useful for pumping or raising water with attached buckets with slow speed pumps, but have such slow speeds that they are very poor for generating electricity or for driving other high speed equipment.

- Advantages:
1. May be quite easily homemade.
 2. Usable on very low heads.
 3. Require a very simple approach and tailrace.

- Disadvantages:
1. Very slow speed.
 2. Variable speed with variable load.
 3. Tendency to freeze in winter.
 4. Heavy and unwieldy.
 5. Very low efficiency.
 6. Difficult to mount, as they must be raised and lowered with variations in stream level.

Overshot Wheels (see cover illustration):

These are good all-purpose wheels for small power installations. If installed with reasonable care, they will operate with high efficiency under a wide range of operating conditions. They are not easily damaged by debris, and if properly constructed and housed should not give trouble from freezing. In general they will require but little attention. Their speed is so slow that gears or a jack shaft will always be necessary for electrical generation, but the fact that they can be home-built usually offsets this disadvantage. In general they can be highly recommended, particularly for heads which do not exceed 15 or 16 feet.

- Advantages:
1. Fairly high efficiency under wide ranges of load and discharge.
 2. Can be homemade quite easily.
 3. Maintenance and repair is comparatively simple.
 4. Slow speed makes wear on buckets and bearings negligible.
 5. Heavy weight has tendency to keep speed steady under sudden load variations.

- Disadvantages:
1. Slow speed is poor for electrical purposes.
 2. Often the large size necessary makes proper housing difficult.
 3. Difficult to govern speed closely if this should be necessary.
 4. Usually requires considerable headrace fluming. Must be clear of tail water at all times or efficiency decreases sharply.

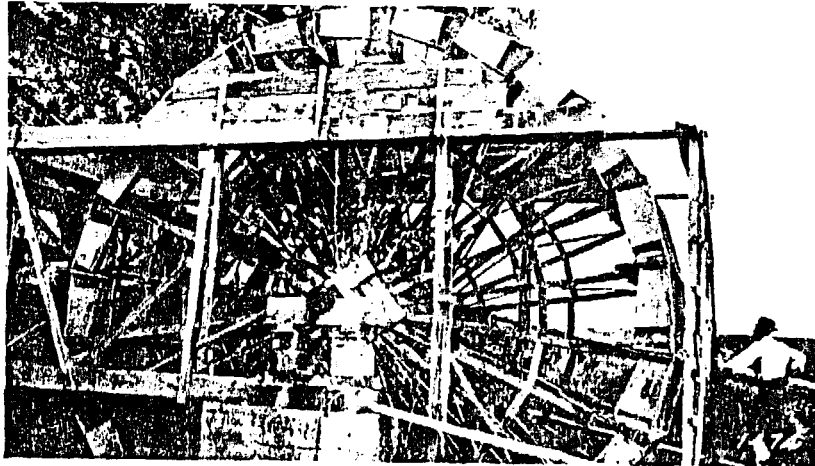

Figure 4. A CURRENT WHEEL WITH BUCKETS FOR LIFTING WATER.

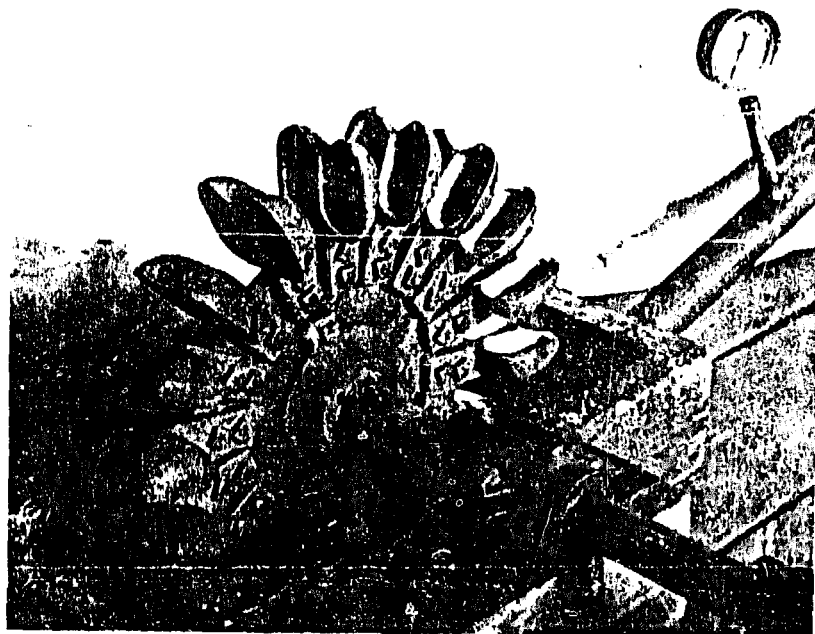

Figure 5. AN IMPULSE WHEEL

This wheel was made in the engineering department of Montana State College, using a saw mandrel and buckets cast in the college foundry. Water enters through the pipe which carries the pressure gage, the nozzle being under the wheel at the right. A tight housing is placed over the wheel during the operation.

Turbines (see figures 3 and 6):

Turbines are of two general types: the reaction, using a Francis runner; and the propeller, using a screw blade. Both work satisfactorily, but in general the propeller type will work better for low heads (3 feet to 12 feet). The propeller type gives a little faster speed, which often makes possible a direct drive to the generator where a belt or gear drive would be required with a Francis type of runner. Use of the screw blade makes possible a lighter, and therefore a slightly less expensive, turbine. However, it does not, in general, have the ruggedness of the reaction type, and is not recommended for the heavier power installations where the head is sufficient to use the reaction type. Most manufacturers supply both types of turbines and will advise which is the best for any particular installation.

- Advantages:
1. Good efficiency under varying load conditions.
 2. High speed, often making possible a direct drive to generator.
 3. Little danger from freezing.
 4. Can use a governor effectively.
 5. Entire unit can be self-contained and very compact.

- Disadvantages:
1. Cannot be homemade easily.
 2. Comparatively expensive.
 3. Often wear badly and replacements are expensive.
 4. Governor is expensive.
 5. Efficiency drops sharply when flow is decreased below normal.

Impulse Wheels (see figure 5):

These are usually used for high heads where most of the energy will be in kinetic form. They must be carefully made to insure good efficiency, so homemade types are not recommended. Governing is accomplished by means of a needle valve in the nozzle. They are much smaller, and lighter, for a given capacity than the turbines, primarily because of the higher head and correspondingly smaller volume of water handled. However, the finer workmanship necessary about offsets any difference there might otherwise be in their cost.

- Advantages:
1. Good efficiency when properly installed with high heads.
 2. High speed makes direct drive of generator possible.
 3. Comparatively small quantities of water needed.

- Disadvantages:
1. Cannot be homemade easily.
 2. Require an accurate nozzle and carefully made cups.
 3. Require carefully designed penstock, making total installation expensive for small sizes.
 4. Splash badly and are very inefficient if not carefully adjusted and accurately governed.
 5. Have a tendency to wear badly because of high speeds.

No estimates of the costs of wheels can be given, because this cost will vary with the head, power output, style, and many other factors. It is suggested that quotations be secured from the manufacturer on the type and style of wheel best suited for the installation contemplated.

Methods of Power Transmission

Electrical transmission of power has become so common that the possibilities of direct drives from water wheels are often overlooked. Direct drives eliminate energy losses through a generator, transmission line, and motor, and if they do not require complicated gearing or line shafts, often make possible the use of very small power outputs which cannot be developed economically in any other way.

Perhaps the most common use for a direct drive is for pumping water. Current wheels are often arranged with buckets in their rims to raise water from the stream. Chain pumps consisting of buckets arranged on a continuous chain, also work well when driven from slow speed current or overshot wheels, but are very low in efficiency. Reciprocating pumps connected by means of a crank or through a draft wire also work well with these wheels. Centrifugal or impeller type pumps should be driven from turbines or impulse wheels, for it is difficult to obtain the high speed necessary to drive these pumps from slow speed water wheels without losing a large portion of the available power.

Occasionally a line shaft can be arranged to transmit power from a water wheel to drive small tool grinders, grindstones, mills, wood saws, churns, washing machines, or other farm and household equipment which need not be moved from place to place.

Unless most of the power output of a wheel can be used through some simple, convenient type of direct drive, however, electrical transmission is recommended, as it makes possible the use of power at any convenient point around the farmstead, and to a greater extent, at any convenient time. Semi-portable equipment can be used, such as vacuum cleaners, farm motors, etc., and it is also possible to use this form of energy directly in the form of heat or light.

While slow speed current and overshot wheels are very satisfactory for use with direct drives, they are poorly adapted for driving electric generators. Special gears or belts will always be necessary to increase the speed to a point where a generator will operate satisfactorily. V-belts and special tread leather belts are very efficient for this purpose, but are much

more expensive than ordinary belting. Gears and chain drives are also very efficient, but likewise are quite expensive. With overshot wheels a single jack shaft will usually give satisfactory results. Current wheels may require a second shaft, though usually their speed is too slow to make a drive to an electric generator practical. Turbines can often be direct-connected, or at most need but a single set of gears or a belt. Impulse wheels are usually connected directly to the electric generator.

Electrical energy may be generated and transmitted as either alternating current (A.C), or direct current (D.C.). Residential supply for cities and towns is usually A.C. and therefore equipment for use on this type of supply is easily available. Alternating current used with transformers may be transmitted for long distances. On the other hand, generating equipment for this form is more expensive than for D.C. and the generator must be driven at a very steady speed. This requires the use of an expensive governor on turbines and impulse wheels, and makes it impractical to supply alternating current from overshot or current wheels. On the other hand, direct current generators are comparatively simple, and can be easily controlled. Proper design makes possible a constant voltage supply under widely varying driving speeds, and this makes a governor unnecessary. These forms of energy will usually be available in different voltages as listed below:

Voltage at plant	Voltage at buildings	Advantages	Disadvantages
8 v. or 16 v. D.C.	6 v. or 12 v. D.C.	Generators easily obtainable from old automobiles. Standard car battery used. Recommended for plants of less than 500 watt capacity.	Very low capacity. Requires large transmission wires.
35-38 v. D.C. (2 wire)	30-35 v. D.C.	Can be used with storage battery. Generating and control equipment is low in comparative cost. Recommended for plants from 0.5 kw. to 1.5 kw. size.	Requires special lamp bulbs and appliances. Requires large wires and cannot be transmitted very far.
120-125v. D.C. (2 wire)	110-120v. D.C.	May use standard lamp bulbs and smaller heating appliances. Battery may be used, but is too expensive to be recommended. Recommended for plants of 1 kw. and 2 kw. capacity where transmission distances are not over 500 feet.	Needs special motors and radio sets. Cannot be used with transformers. Not practical for capacities of more than about 2 kw.
125-250v. D.C. (3 wire)	120-240v. D.C.	May use standard lamp bulbs and heating appliances. Uses comparatively inexpensive generating equipment which does not require a governor.	Needs special motors and radio sets designed for this type of power supply. Cannot be used with small transformers for toy trains, door bells, etc.
125-250v. A.C. (2 or 3 wire)	120-240v. A.C.	Standard supply. Therefore appliances and equipment easily obtainable. May be transformed and transmitted long distances. Recommended for larger plants (5 kw. or more) and for plants which will supply more than one farmstead.	Generating equipment is relatively expensive. Requires use of a sensitive and therefore relatively expensive governor.

Survey and Design Data For Complete Plant

The maps and plans need not be elaborate, but they should be complete in all details. Too much information is better than not enough. In general, the finished plans should include:

1. A map of the dam, stream, canal, flumes, penstock, tailrace, etc.
2. A cross-section of the dam and spillway, with other construction data.
3. Plans of head race or penstock, showing trash rack, water controls, and similar features (see figure 6).
4. Plans of the water wheel or turbine installation, showing mounting, delivery of water to the wheel, governor control, and other details.
5. Diagram of wiring system complete for each building, similar to the plan shown in figure 7, showing location of all outlets, branch circuits, etc.
6. A plan of the farmstead showing all distances to and between buildings.

Checking Finished Plans

If it has not been possible to consult an engineer in making the preliminary survey and plans, one should be engaged to check over the finished plans and make criticisms and any changes which may be necessary. If a commercial wheel is used, the company furnishing the wheel will be glad to have their engineering department do this, as they will require most or all of this information before they can make an intelligent suggestion as to type and size of wheel or turbine necessary. In addition to these plans, it will be well to include the following data when requesting information from a water wheel manufacturer:

1. Measurement of head and description of how it was taken.
2. Measurement of maximum and minimum volume of flow with dimensions of weir or other information on how measurement was made.
3. List of uses to which power will be put.
4. Information concerning any water power equipment which may be on hand.
5. Any other information which may be useful.

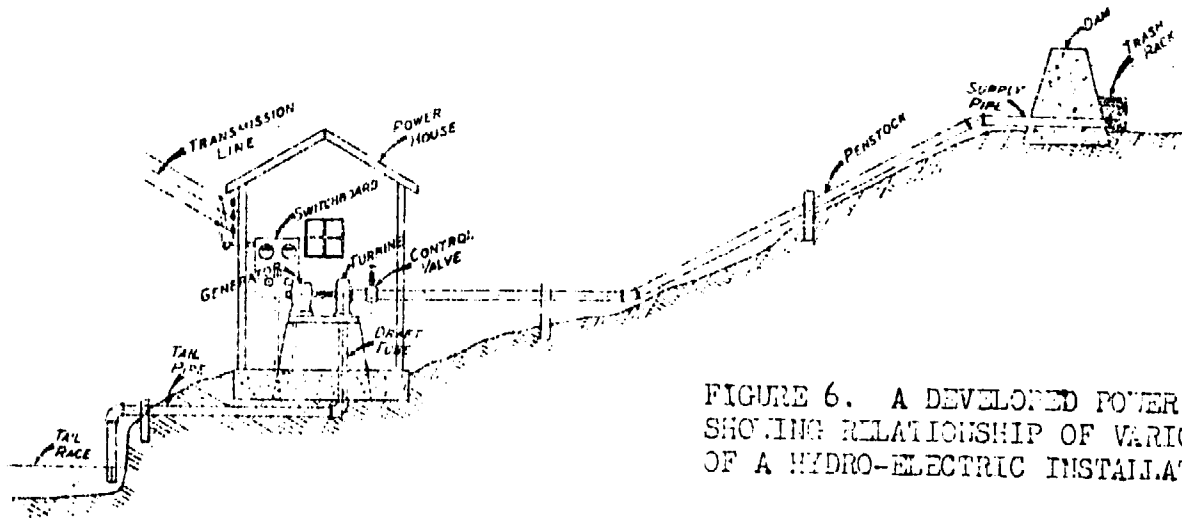
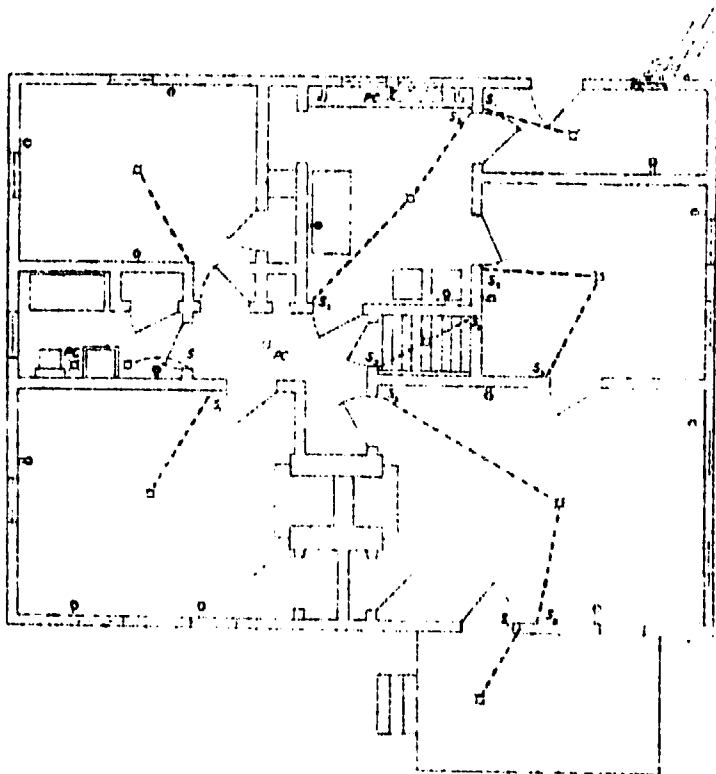

FIGURE 6. A DEVELOPED POWER SITE SHOWING RELATIONSHIP OF VARIOUS PARTS OF A HYDRO-ELECTRIC INSTALLATION



WIRING SYMBOLS

- GEILING LIGHT OUTLET
- PC□ GEILING LIGHT OUTLET WITH PULL CORD
- ⊖ WALL LIGHT WITH CONVENIENCE OUTLET
- ⊖ CONVENIENCE OUTLET
- ⊖ HEAVY DUTY OUTLET
- S ONE WAY SWITCH
- S, THREE WAY SWITCH
- ▣ SERVICE ENTRANCE EQUIPMENT

FIGURE 7. A HOUSE WIRING PLAN

This need not include a wiring diagram, but should show the location of all outlets, fixtures, switches, and other equipment which will be permanently attached to the wiring system.

PART II.

DAMS AND WATER CONTROLS

A dam, in most cases, is not needed for a current wheel, since control is effected by raising or lowering the wheel to conform to the level of the water in the stream. In other cases, when the wheel is installed in a flume, control is accomplished by means of a low diversion dam built of loose rock, or by a number of piles driven into the stream bed to which a heavy plank may be tailed.

For all other types of water wheels a dam is needed for the diversion and control of the water. Only a brief description is given here of the construction of different types of dams.

There are two main purposes for which dams are usually constructed: first, for the impounding or storage of water, as in a reservoir; second, for the diversion of all or a part of the flow of a stream.

The first type of dam must be designed to withstand considerable pressure, since it always involves raising of the water surface to a considerable height. To withstand pressure, the dam must be securely anchored to its foundation to prevent sliding downstream due to the pressure from the water impounded on the upstream side. It must also have sufficient weight to withstand both sliding and overturning. In addition to this, enough rigidity must be built into the dam so that it will not crumble under the stresses imposed upon it. Storage dams may be built of earth fill or of masonry. In either case the same fundamental principles concerning the pressure of water must be followed.

For small water power installations a dam of great height will probably not be needed, and therefore should not be difficult of construction by any farmer. Simple directions for the preparation of dam sites and the construction of small dams are given in Montana Extension Bulletin 180.

At times diversion dams also may have to withstand heavy pressure, since it may become necessary to raise the water surface a considerable distance to get the stream out of its deep channel. In diverting water from a stream, often only a part of the flow is needed, especially during high water. To allow this excess water to flow down the creek without washing out or otherwise endangering the dam, the "overflow" type of dam is needed in which the spillway is built into and becomes a part of the dam itself. Diversion dams of this type may be built of reinforced concrete, but these are generally too costly for farm construction, so structures are suggested which can be built of local materials and at a lower cost.

One of the simplest of these is the rock and brush dam. An illustration is given in figure 8. It should be constructed with sufficient weight and rigidity to withstand the pressure and the erosive action of the water. The foundation should begin well below the stream bed and in firm material. The lower face of the dam should be built up with layers of brush weighted down with rock and each successive layer of brush should be set back from the previous one on the ratio of about two to one; that is, two feet horizontal for each foot of rise. The main body of the dam is constructed of earth fill which, too, should begin well below the stream bed on a firm foundation. The ends of the dam should be built three or four feet higher than the spillway section, and the sides of this spillway should be protected with brush and rock securely anchored into the earth fill.

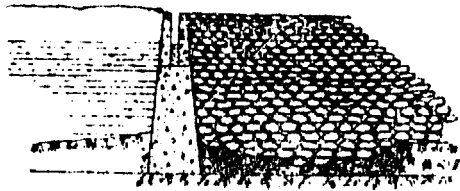

(A) CONCRETE CHECK WALL

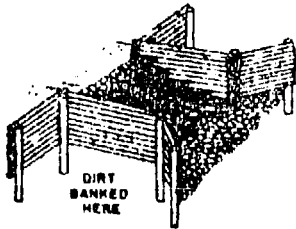

(B) BRUSH AND ROCK DAM

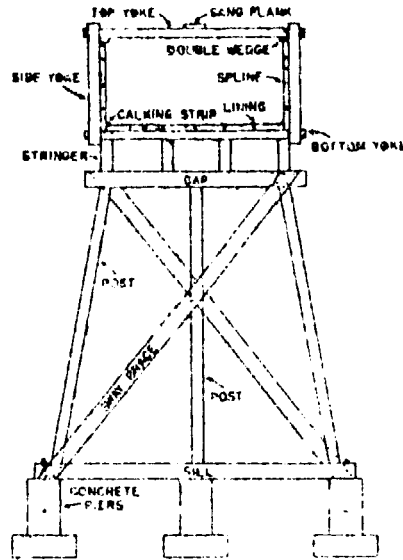

(D) FLUME CONSTRUCTION

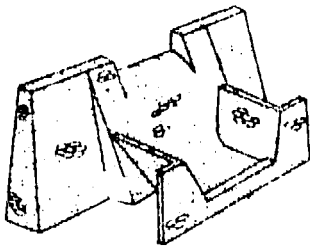

(C) RUBBLE MASONRY SPILLWAY

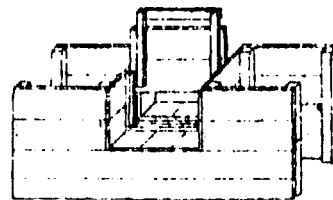

(E) WOOD HEAD-GATE

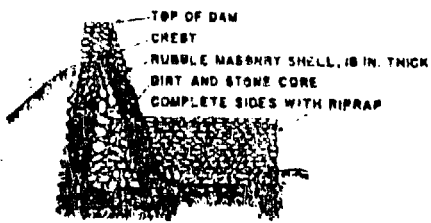

FIGURE 8. CONSTRUCTION OF DAMS, FLUMES, AND HEADGATES

Another type of dam which may also be constructed from local materials is a "rough rubble masonry" type, such as is shown in figure 8. This dam consists of a face of solid masonry with an earth fill behind it of such dimensions and weight as to resist the pressure of the water. At the foot of the dam a rock apron is built, upon which the overflow water will fall. The level of this apron should be one foot below the level of the stream bed so that the overflowing waters fall into a water cushion before flowing out into the channel below. The rock on the face of the dam should be laid with cement mortar, but the inside or core of the dam may be filled in with rock and clay. The side walls and wing walls should be well anchored into the earth at each end of the dam to prevent leakage at these points. Above the dam the earth fill should have a slope of three to one down into the water. Thus, the flow of the water is prevented by the earth fill, and the masonry is used primarily for the spillway, which is part of the dam itself.

Timber cribs filled with rock and backed with an earth fill may also be used for diverting water into a power flume. If the lift is not great—say not over four or five feet—a wooden diversion dam may be used with safety and the water level controlled by means of flash boards or a headgate.

There are as many ways of building dams as there are locations for them, and the farmer can adapt the design to fit the conditions which are present, keeping in mind always that the fundamental principles governing pressure and water erosion must be followed if failure is to be avoided.

To convey the water from the reservoir or diversion dam to the water wheel, a canal or flume must be constructed of ample capacity to carry the maximum flow needed for the operation of the plant. Since a constant flow is usually desired in the canal, a headgate and wasteway must be installed at the intake to provide complete and constant control over the water flowing over the wheel. The underflow type of headgate is best suited for this purpose. The flow is regulated by raising or lowering the headgate. In front of the headgate a trash rack should be built to prevent entrance of rubbish which might clog the water wheel.

The headgate should be securely anchored into the banks as shown in figure 8, to prevent all flow of water around the ends. If wooden structures are used, the wood should be given a coat of creosote or other protective material to prevent rapid deterioration. It is a good plan, also, to use heavy dimensioned material, since this will make a more substantial gate and decay will progress more slowly. Reinforced concrete with wooden headboards is highly desirable wherever this type of construction can be afforded. All headgates should be securely anchored and protected to prevent water washing around or under them. For long supply ditches a second headgate will be necessary near the water wheel or turbine so that the flow can be regulated conveniently and quickly.

An important rule to keep in mind in using concrete is that only clean, sharp sand and gravel should be used, and that there should be no skimping in the amount of cement. Any concrete mixture with an insufficient amount of cement, which is its binding material, is liable to failure at any time and never can be depended on.

PART III. CONSTRUCTION AND INSTALLATION OF HYDRO-ELECTRIC PLANTS

Electricity provides one of the most convenient methods for transmitting the power developed by a small water power plant. It will allow the use of appliances and equipment in more convenient locations than will otherwise be possible. It will make it possible to operate a larger variety of appliances and equipment, and will therefore make the power development more useful. Also, as mentioned previously, it makes possible the use of water power for furnishing heat and light.

The disadvantages of electrical transmission are found in the added cost of the electrical equipment, and in the additional energy losses which occur in the electrical equipment. These objections are usually far outweighed by the advantages which are gained, but nevertheless they should be given proper consideration.

Energy losses in hydro-electric installations, in addition to those found in the water power plant, are:

1. Mechanical losses in bearings, gears, belts, shafting, etc., of the generator drive.
2. Electrical and mechanical losses in the generator.
3. Electrical losses in transmission lines and wiring.
4. Electrical and mechanical losses in motors and appliances.

Overall hydro-electric efficiencies, which do not take into account the last two of these losses, will run from very small values for crude installations to as high as 50% or 60% for carefully designed and constructed plants. More detailed information on what may be expected can be obtained from appendix II. Transmission losses should be kept well under 5%, and motors can be expected to have an efficiency of from 75% to 85%.

SIZE OF GENERATING PLANT REQUIRED

Generally speaking, hydro-electric plants which will not deliver at least 500 watts (approximately one-half horsepower) at all seasons of the year, will not be worth the investment necessary for their construction. Very small plants of this type, driving an automobile type of generator and using a small automobile type storage battery, can furnish enough energy for a few lights and a radio. Plants which can furnish between 500 and 1000 watts can supply enough energy for most of the necessary lights in a small farm home, and may even operate a few small appliances. One kilowatt (1000 watts) will light about 15 sixty-watt lamps, or will operate an electric iron if nothing else is connected at the same time. This power will also operate a washing machine, a water pump, and most small household appliances provided that not more than about 900 watts (because of transmission losses) is connected at any one time.

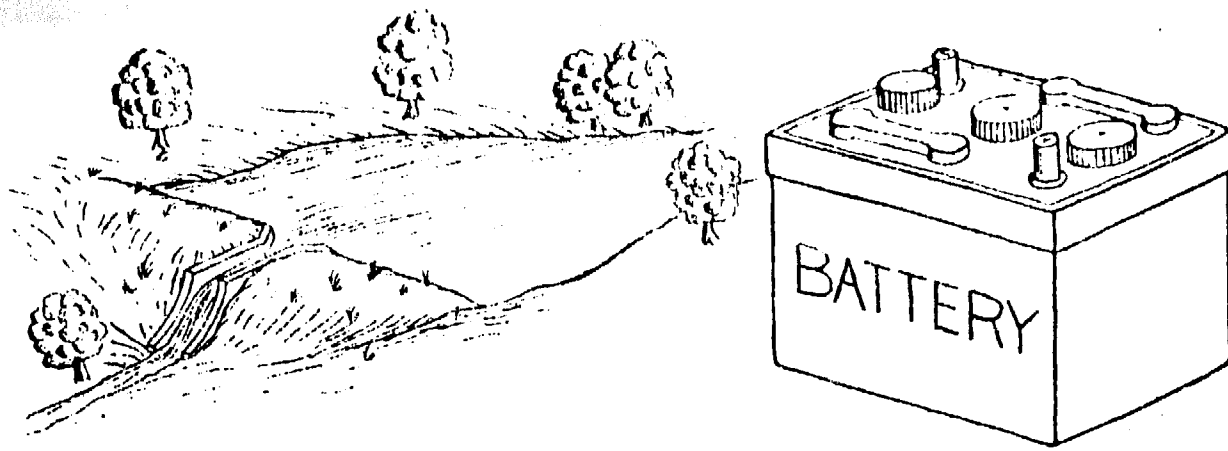

STORAGE POND

FIGURE 9. TWO WAYS OF STORING ENERGY

A FEW
LIGHTS



ELECTRIC
WASHER



RADIO

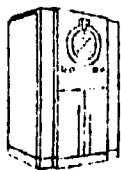

ELECTRIC IRON

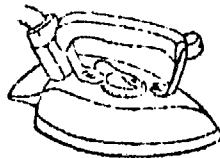

VACUM
CLEANER



ELECTRIC
TOASTER

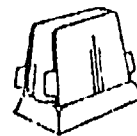

ELECTRIC
REFRIGERATOR

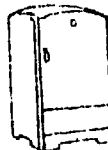

WATER SYSTEM



FIGURE 10. USES OF ENERGY
FROM A PLANT OF LESS THAN
1 KILOWATT CAPACITY

FIGURE 11. ADDITIONAL USES OF
ENERGY FROM A PLANT OF FROM
1 TO 3 KILOWATTS CAPACITY

FARM MOTOR

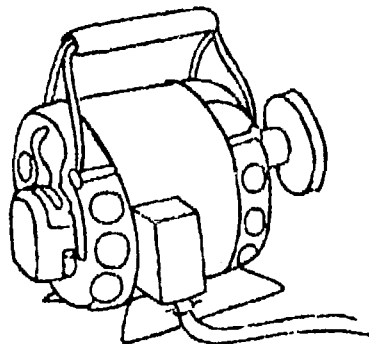

ELECTRIC RANGE

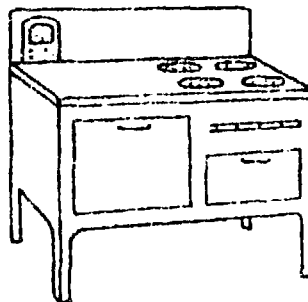

FEED GRINDER

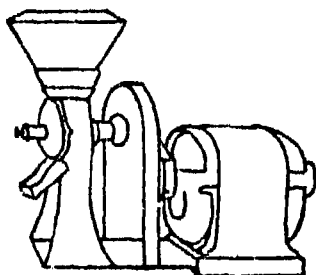

WALK-IN COOLER

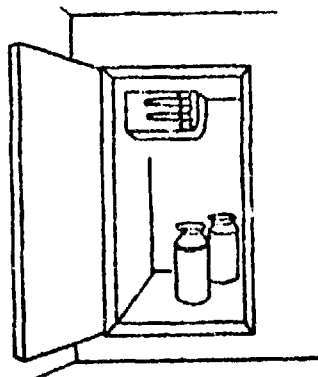

FIGURE 12. ADDITIONAL USES OF ENERGY FROM A 4 TO 5
KILOWATT PLANT

Those larger plants will furnish energy for these and similar
uses, in addition to those shown in figures 8 and 9.

Installations which deliver 1.5 kilowatts or less should have a storage battery. This means that such plants should be of the 32 volt type or less, for batteries used with higher voltage plants are too expensive to be practical. Storage of energy can be done either in a pond or in a battery, and sufficient storage capacity to handle daily fluctuations in power demand will approximately double the usefulness of an installation. Pond storage will require a dam, and a suitable reservoir area, of course; but it may make possible an effective use of a 120 or a 240 volt plant with its added advantages. On the other hand, a storage battery is quite expensive, and will require occasional replacement, thus adding to operating expense. A 32 volt plant will require larger wire for the transmission lines, and slightly more expensive appliances than will be necessary if the higher voltage can be used.

Two kilowatts supplied by the generator will operate up to 1300 watts without any difficulty. This means that almost any household appliance, even including an electric ironer (mangle) can be used. Electric water heating will be possible if not more than 1500 watts are used in the heater elements. A refrigerator can also be installed safely on this size of installation. Small motors can be used around the farm, and there will be plenty of power for pumping water and for lighting.

If an electric range is desired, at least 3 kilowatts must be delivered by the generator. Even this amount will not operate such equipment in addition to the range if the oven or several of the surface units are on at one time. A battery is usually not practical in connection with a range, because the large capacity which would be required would make its cost prohibitive.

Five kilowatts will supply most of the ordinary electrical needs of an average farmstead. This will run small feed grinders, silage cutters and blowers, wood saws, milking machines, etc., and will also furnish ample power for a range and other household appliances. Such an installation, if capable of delivering full capacity at all times, is a very satisfactory one. Larger installations cost less per unit of power capacity, but unless there is a definite demand for the additional power, they are not recommended for supplying ordinary farmstead power demands. Total costs are higher for the larger sized equipment, and the additional capacity will not be any great advantage unless there is a definite demand for it.

Details of Hydro-Electric Plants

Good quality equipment is necessary to convert the major part of the mechanical power derived from a wheel or turbine into electrical energy. This equipment is quite expensive, but will pay for itself many times over in satisfactory operation.

The Generator:

Generators can usually be purchased complete with full instructions for their operation and care. A.C. generators must have some special provision for supplying direct current to their field coils, and this is usually done by means of a small auxiliary generator (called an exciter) mounted on

the generator shaft or by means of a special set of windings within the generator itself. Also, these generators will require a special governor on the driving turbine or water wheel to keep their speed constant. In addition, there will be a voltage regulator to maintain a constant output voltage. This regulator can be adjusted so that it will maintain a constant voltage at some point near the farm buildings. Thus in ordering a generator it will be necessary to indicate the distance from the power plant to the farm buildings and to show the types of electric equipment which will probably be used in each building.

D.C. generators will probably be "compound" wound. Generators of this type can be so regulated that they will deliver constant voltage under a wide variation of driving speeds, making a governor unnecessary. They can also be adjusted to hold the voltage constant at some point on the farmstead, without the need of a special regulator.

Generators will require little attention, but this little they must have. Manufacturers' directions for lubrication must be followed to the letter. All fuses must be properly installed and well maintained. Otherwise a short circuit may burn out the generator. Generators must be kept free of dust and dirt accumulation, and they should be located so that water can not splash on them. In some cases it may be necessary to shield them with a metal or wooden cover. Brushes will have to be replaced occasionally as they wear down and begin to spark. Replacement brushes should be ordered from the manufacturer, although most distributors of electrical supplies also can furnish them. In ordering brushes, always give all of the information on the generator name-plate.

The Switchboard:

Usually the switchboard will be supplied with the generator. This board carries switches to control the electrical circuits from the generator; meters to indicate the voltage and current; a rheostat for manual control of the voltage output; a regulator, if one is necessary; and the main fuses. With sets where a battery is used, a battery switch is also provided. This makes it possible for the plant to charge the battery alone, or for the battery alone to supply the main line, or for the battery to be connected across the line.

The fuses on the switchboard should be of such size that they will blow if the generator is overloaded. They should not be tampered with in any manner, for their purpose is to protect the expensive generating equipment. In case they keep blowing, and no defect is found in the transmission lines or in any connected equipment, it may be that too much equipment is being connected to the line, and then either some of this load must be removed, or the capacity of the water plant, generator, and transmission system be increased to care for it.

The Battery:

Small capacity plants will usually have a battery and this battery should have good care at all times if it is to give maximum service. Manufacturers give full directions in installation and care of batteries, but a few of the more important general directions are listed as follows:

Install batteries in a clean, dry place and in a well lighted room, but do not allow direct sunlight to fall on them nor allow open flames near them. Have the room well insulated against severe temperature ranges. Temperatures higher than 95 degrees F. are damaging, although low temperatures do little damage if the battery is kept well charged. The floor should be of concrete and designed so that it can be kept clean easily.

The charge on the batteries must be watched closely and not allowed to get too low. Operation at low charge will quickly damage batteries, and is one of the primary causes of battery failure. It is well to give the battery an overcharge about once every two weeks to completely oxidize the sulphate. At other times judicious use of energy will allow the battery to discharge about as much as it charges. For example, if it discharges at the rate of 5 amperes during heavy load, and averages this for a period of 3 hours a day, there should be 3 hours during which it charges at about 5 amperes (or a little over to make up for losses in the battery). A charge of $2\frac{1}{2}$ amperes for 6 hours will also replace this energy. In other words, the amount of current multiplied by the length of time of charge should a little more than equal the amount of current multiplied by the length of time of discharge for each 24-hour day. Then about one day every two weeks the amount of charge should be increased to two or more times normal.

Lead storage batteries can easily be tested for charge by means of a hydrometer, following manufacturers' directions. A voltmeter should not be used alone as it gives but little indication of the charge; and an ammeter, if placed across the battery terminals, will quickly burn out. Battery testers of course are satisfactory.

Good quality batteries, when well taken care of, have been known to last ten years, or even longer. However, if allowed to discharge so that they "sulphate", or if otherwise not carefully taken care of, they can easily be ruined in a short time.

Transmission Lines:

Transmission lines should be built to last indefinitely. Sloppy construction will cause excessive line losses, and will never be satisfactory. Wire must be the proper size as indicated in table 4, otherwise proper voltage cannot be delivered. Poles should be good quality, large and straight, and should be properly treated with creosote or other wood preservative to insure long life. The line should be run as straight as possible, with all corners well guyed or braced to substantial steel anchors or "dead men". Insulators should be of porcelain, or pyrex glass (not ordinary glass telephone line insulators) designed for the line voltage which is used. Wires should be tied to the insulators as shown in figure 13a. If it is necessary to "dead end" the line on a pole, two cross-arms should be used with wires fastened as shown in figure 13c. All line wires can be bare, but all wires leading from the pole line to buildings should be weatherproof covered, and should be connected to the buildings by means of pull-knobs or service racks such as shown in figure 13b and figure 14. Short lines may use service racks instead of cross-arms if the voltage does not exceed 250 volts. All wires hung on service racks should be weatherproof covered.

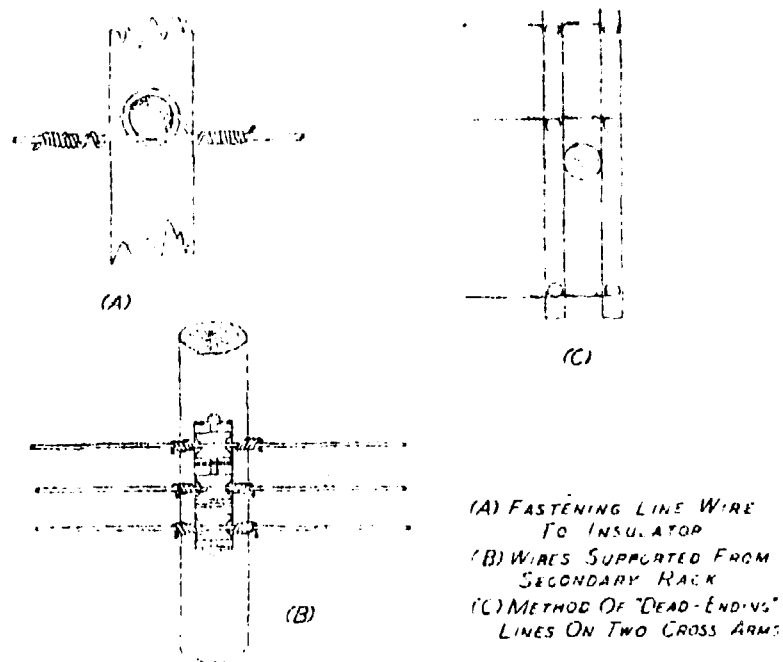

FIGURE 13. DETAILS OF TRANSMISSION LINE CONSTRUCTION

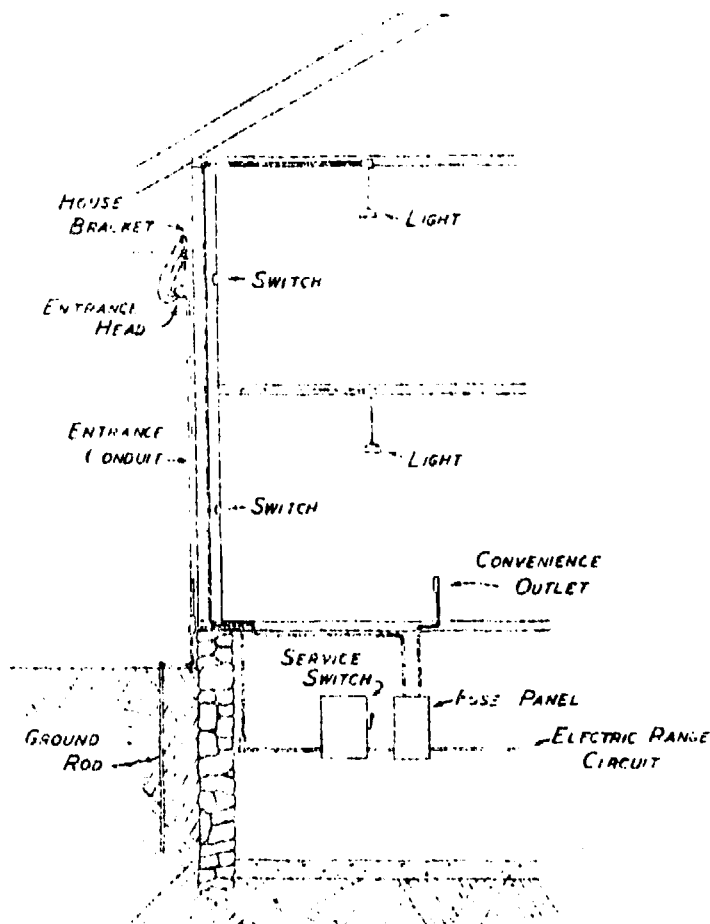

FIGURE 14. DETAILS OF ENTRANCE TO A RESIDENCE

Protection from lightning is obtained by connecting a ground rod to the neutral line directly below the entrance.

The sizes of wires which should be used in transmission lines can be determined from table 4, appendix IV, which gives the maximum length in feet for any of the common wire sizes if an excessive line loss is to be avoided. For instance, if a 3 kilowatt plant is to be located 500 feet from the farm buildings, No. 2 wire will have to be used if 120 volts are available, but No. 8 will be satisfactory if the plant supplies 240 volts. (These sizes would also be satisfactory for lines over 600 feet long.)

The advice or help of an experienced lineman will be invaluable in the installation of a permanent, satisfactory transmission line. Such a person will also know how to obtain proper materials, and the added service from the line will more than offset the cost of his services.

Entrances to Buildings:

Where the wires enter the buildings suitable "entrances" must be installed. These should be either in conduit or in service entrance cable. Suitable service heads are necessary at the upper end of either the conduit or the cable. Rubber covered wire at least as large as the line wire should extend from this head far enough that a drip loop can be made and the wire fastened to the incoming line wires as shown in figure 14. This conduit or entrance cable leads directly to the entrance switch and fuse block inside the building. One of these switches should be placed in each wired building, and located so that it can be opened easily in case of fire.

Types of Wiring:

Interior wiring is specialized work and should be done by a competent electrician. Improperly installed wiring offers many hazards from fire and electric shock which can be entirely eliminated by proper installation. All wiring should be done in accordance with the regulations of the National Electric Code, for only in this way can all danger from faulty wiring be removed. Also, it has been found that "Code" wiring by a competent electrician is little, if any, more expensive than work done by unskilled workers. Materials will cost approximately the same in either case--in fact the electrical contractor can usually pass on valuable discounts if he puts in the work--and because of his skill the experienced wireman can usually work enough faster than the unskilled worker that he makes up for the difference in wage rates.

Three types of wiring are generally used in houses and farm buildings. These are: (1) "knob and tube", using single rubber covered conductors mounted on porcelain insulators as shown in figure 15; (2) armored cable, using two rubber covered conductors inside of a flexible steel conduit as shown in figure 16; and (3) non-metallic sheathed cable, in which the conductors are enclosed in a fibrous outer covering as shown in figure 17. In addition, it is possible to use conduit or "thin-wall tubing" to hold the conductors, although these methods are more expensive and therefore not widely used.

The size of conductor used is very important; as conductors which are too small will use an excessive amount of energy, possibly heating badly and forming a fire hazard, and also causing equipment to operate inefficiently.

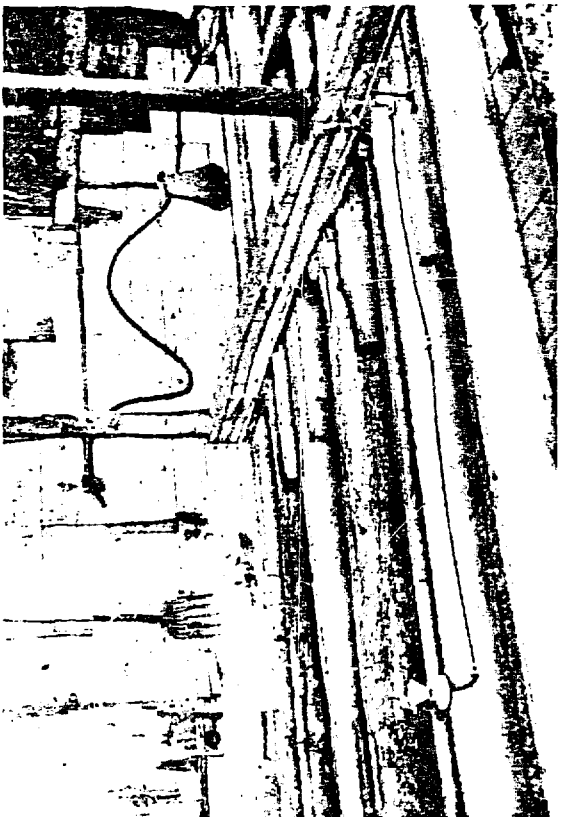

Figure 15. OPEN KNOB AND TUBE WIRING IN A BARN.

The white wire is the neutral line. This type of wiring is protected by running it close to beams and joists. Notice the additional protection (loom) where the wire enters the outlet box above the light.

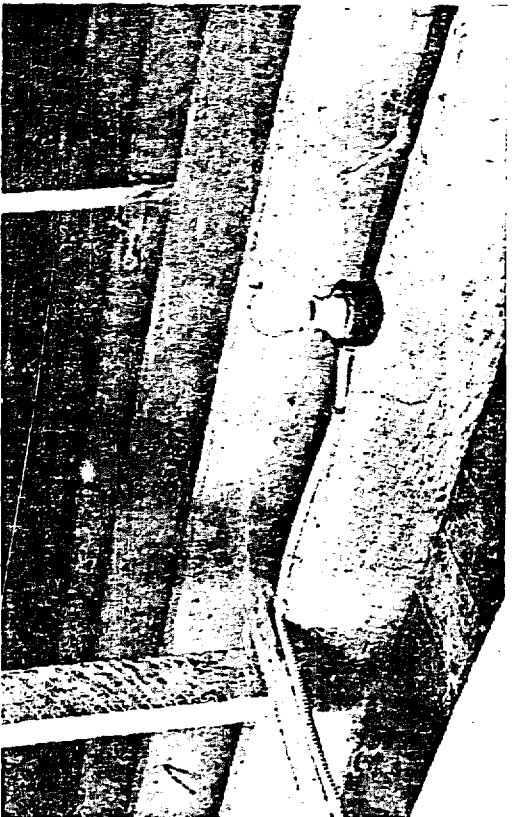

Figure 16. ARMORED CABLE WIRING IN A GRANARY.

Cable must be securely clamped to outlet boxes and should be well supported between outlets. This is an excellent type of wiring for open, dry locations.

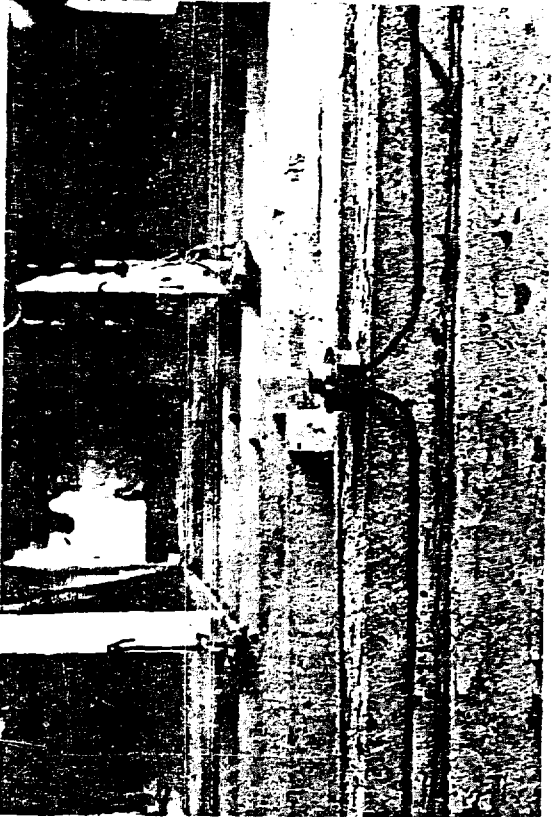

Figure 17. NON-METALLIC SHEATHED CABLE IN A DAIRY BARN.

This type of wiring is excellent for stables where fumes might attack metal, or for concealed work in finished buildings where wiring must be "fished" from outlet to outlet. Wiring in damp locations should be lead covered.

Table 5, appendix IV, indicates the minimum sizes of conductors to use with different systems and for various purposes. Any circuits longer than 40 or 50 feet should use at least one size larger than that indicated.

Outlets and Switches:

Plenty of convenience outlets should be provided. Wiring regulations require at least two in the kitchen, dining room, living room, or similar room, and at least one in each hallway and bedroom. At first this may seem too many, but experience has shown that more outlets than this are usually needed, and these are much more expensive to install singly than at the time the whole house is being wired. Barns and outbuildings should also have plenty of outlets for all future needs. These must be of sufficient capacity to supply the amount of current which will be drawn from them. The number of outlets will depend to a great extent upon the power output of the plant. Small plants cannot supply very many different appliances, so of course it is necessary to install only a few outlets. However, the above recommendations on number of outlets should be applied whenever more than 1.5 kilowatts are available.

Wall switches are very important items which are often overlooked in planning wiring installations. If they are not provided, it is necessary to turn lights off by means of a key or pull chain on the socket or light fixture. This jerks the bulb a little, and materially shortens its life. Wall switches will pay for themselves many times over in the lifetime of an installation. In addition, they are so much more convenient that no installation should be made without them. Three-way and four-way switches should be installed at each of the principal entrances to important rooms such as kitchen and living room so that it is not necessary to stumble across a dark room to find a switch. Switches should be provided on kitchen outlets, and on the washing machine outlet also. Most small appliances do not have switches on them, and if they are turned on and off by inserting and pulling the plug on the extension cord, this quickly damages the receptacle contact and causes the appliances to operate inefficiently. Switches are for convenience and for providing good circuit contacts for a long life installation. They should be used freely throughout the house and in all the outbuildings. Switches are particularly required to prevent damage to contacts and equipment used on low voltage D.C. systems (6 to 40 volts). Because of the heavy currents, these switches should be the heaviest obtainable and should never be less than 10 ampere capacity.

Protection of Electrical Equipment

Two dangers exist in an electric circuit. One is that too much current will flow along a wire, causing it to heat, or causing contacts to heat so much that insulation is damaged and possibly a fire is started. The other is that too high a voltage will be impressed on the lines as a result of lightning or some other cause.

Fuses or circuit breakers protect wiring from damage by too large a current. They should therefore be of the proper size. Wiring code requirements are very specific upon both of these points and must be followed if

danger is to be avoided.

Danger from lightning is avoided by "grounding" one wire. In direct current systems this is the negative wire of two-wire systems, or the "central" wire of three-wire systems. In alternating current two-wire systems it can be either wire. Grounding should be done at the power plant and again at the entrance to each building with a maximum dimension of 50 feet or more. It is accomplished by extending a wire No. 6 A.W.G. size or larger (refer to National Electric Code for more detailed directions) from the line wire down the side of the building (it need not be insulated in any way, but merely stapled to the building). At the lower end it is clamped (not soldered) to a heavy grounded rod. This rod should not be smaller than one-half inch diameter if of copper, or it may be galvanized iron pipe not less than three-fourths inch nominal size. It should be driven into the ground a distance of not less than 8 feet, and should not extend above the ground. The clamp should be one approved for this purpose. If it is impossible to drive a suitable ground rod, a copper plate four feet square or larger can be imbedded at least four feet below the surface of the ground, or at least 40 feet of bare copper wire, not less than No. 4 A.W.G. size, could be laid back and forth along a trench ten feet long and four feet deep. Such buried grounds should be covered with loam (not clay) or fine sand to hold water, and during dry season should be wetted down occasionally.

All wiring must be neatly installed and well protected from damage. Exposed wiring should not be allowed in living quarters. Concealed wiring or wiring run in neat metal raceways is not much more expensive, looks much better than open wiring, and will be safe for a longer time. Non-metallic cable must be protected by guard rails or conduit when within reach or where exposed to any hazards. Open wiring must likewise be protected.

If some care is taken and an effort is made to obtain a satisfactory, safe installation, rather than the cheapest one which will cause a lamp to light, the electrical installation should give many years of good service with little or no care or attention. Such an installation, providing reliable, steady power from a well installed water power plant, can bring comfort and satisfaction which can hardly be realized in any other manner.

* * *
*

To discuss intelligently the principles which govern water wheel construction and operation, it is necessary to understand the exact meaning of certain words which are commonly, but often loosely, used. Some of the more important of these are discussed here briefly so that there may be no misunderstanding of their meaning.

"Force" is generally considered as an action which tends to cause an object to move or to change its motion, in other words to speed up, slow down, change its direction, etc. "Work" is done whenever a force causes an object to move. The distance which the object moves, multiplied by the strength of the force, gives the amount of work done. Since distance is usually measured in feet, and force in pounds, work can be measured in "foot-pounds", one foot-pound being the amount of work done when a force of one pound moves an object one foot. For instance, a 10-gallon can of water will weigh roughly (including weight of can) 110 pounds, or in other words, it will take a force of 110 pounds to lift the can. If a man lifts this amount three feet, he will do 3×110 or 330 foot-pounds of work.

This can of water may now be hung from a rope over a pulley in such a way that when it descends again it will lift nearly its own weight the same distance. In other words, the can of water has become capable of doing work because work was done on it when the man lifted it to a higher position. This ability to do work is called "energy".

In the example just described, the can of water had energy because of its elevated position. This form is referred to as "potential" energy. Now if an object is moving, it will take force to bring it to rest. Since both the resisting force and the object will be moving while the object is being stopped, work will be done. In other words, the moving body had energy because of its motion. This form is called "kinetic" energy. An object can also have energy because of its internal condition as in the case of a compressed spring, or water under pressure, or because of its electrical or chemical condition, or because of other conditions which give it a capacity to do work. These forms of energy can be changed one into another, but it must be kept in mind that energy cannot be created out of nothing, and that it is impossible to obtain more energy from any type of machinery or equipment than was originally available. Often, however, attempts have been made to do this very thing with water power equipment, and of course the results have always been disappointing.

Work can be thought of in another way now, for it represents a change in the form of energy. Energy and work can therefore be measured by means of the same units, that is, in foot-pounds. It will be noticed that this measurement does not take into account the time required to accomplish a given amount of work. For example, "a man can do as much work as a horse"; but he must take a longer time to do it.

Sometimes it is necessary to measure the speed or "rate" at which work is done. This rate is called "power" and should not be confused with the work itself or with energy. The most commonly used unit of power, called the "horsepower", represents 550 foot-pounds of work done each second. The "watt" or "kilowatt" (1000 watts) are generally used when referring to electrical

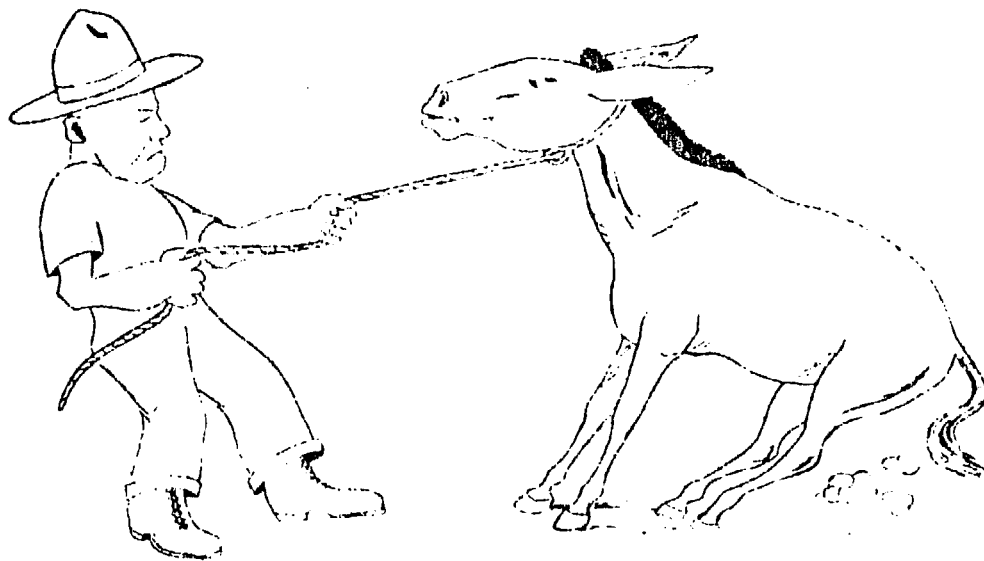

WORK = FORCE \times DISTANCE

FIGURE 18. A DEFINITION OF WORK

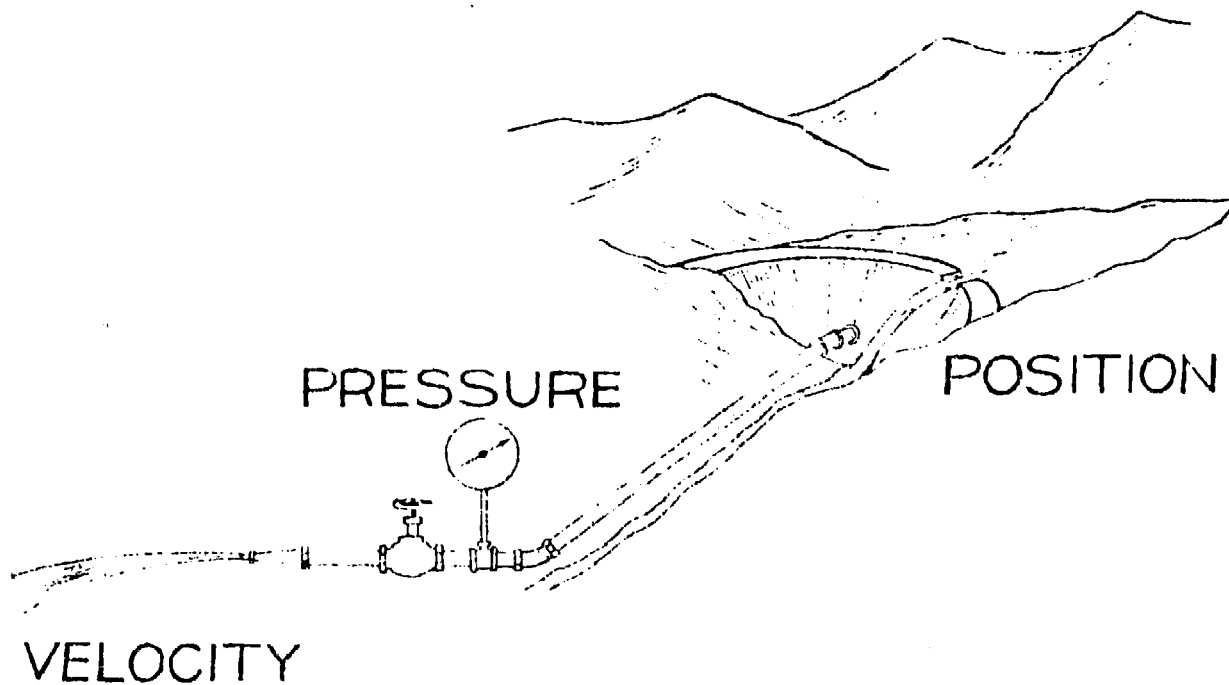

FIGURE 19. THREE FORMS OF ENERGY

equipment. There are approximately 746 watts in one horsepower, and therefore either of these units may be converted into the other. One kilowatt of power used for one hour is called a "kilowatt-hour". Likewise, a horsepower used for one hour is a "horsepower-hour". These are again energy units similar to the foot-pound, but of course very much larger.

Water can be put to work in three different ways. First, it may do work while falling, as over an overshot water wheel, thus using its potential energy; or second, it may use its kinetic energy due to its motion, by moving through an undershot or current wheel, or by flowing through a nozzle into an impulse wheel. A third way is to use the pressure which may be found at the bottom of a standpipe or reservoir. This can be used along with velocity, in a turbine. If a given quantity of water is put to work in any one of these three ways, and if the distance of fall in the first case is the same as that required to give the velocity in the second (with a free fall), and if this in turn is the same as the depth required to produce the pressure in the third case, it can be shown that the work done will be theoretically the same. This depth or height of fall is called "head", or sometimes "velocity head" or "pressure head" to indicate the form of the corresponding energy. In any case, the energy available in the water depends upon the head and the amount or quantity of water available and upon these two factors alone. Likewise, the available power depends upon the head and the rate of flow which can be obtained. A clear understanding of these points is essential.

APPENDIX II.

DETERMINATION OF AVAILABLE POWER

An approximation of the developed power which can be expected from a water power plant is given in table 1, which lists the approximate power output from a flow of one cubic foot of water per second under various heads, and with various types of wheels. In order to find the amount of power which can be expected from a given installation, simply multiply the flow in second feet by the factor found in the table opposite the given effective head for the type of wheel and drive which is planned.

The "effective" head as used in the table is the head available at the wheel, not taking into account any losses through flumes, penstocks, head-gates, etc. In turbine developments with heads up to 10 or 15 feet, it is often possible to convey the water directly to the turbine with a very short flume or penstock of the type shown in figure 3. In this case practically all of the head is effective. In a longer flume, canal, or penstock, from 5 per cent to 10 per cent of the total available head will be lost in conducting the water to the plant. This loss should be corrected for in estimating the power which can be delivered by the wheel. In addition, mechanical, electrical, and other losses which are not taken into account in the table should also receive proper consideration.

In case a given power output is desired, and the required flow in second feet must be calculated, the proper factor should be selected from table 1, and divided into the given power output. For example, if a direct turbine drive is planned, and the available "effective" head is fifteen feet, how much water is needed to furnish 5 kilowatt output at the generator? Divide 5 by the factor 0.76 found in the table opposite 15 and in the column headed "Turbine-direct drive", and the answer is 6.58 or about 6.6 second feet of water required.

For purposes of direct calculation, table 2 gives approximately the range in efficiencies which can be expected from various types of water wheels, and water power plants.

Table 3 gives the head in feet which is equivalent to any given velocity. Theoretically, this head of water will give a velocity of the amount indicated. Actually a considerable portion will be lost in making the change from potential to kinetic energy.

TABLE 1.--POWER OUTPUT OF DIFFERENT TYPES OF WATER WHEELS WITH FLOW OF ONE SECOND-FOOT AT DIFFERENT HEADS

Effective head at wheel, feet	Power output on wheel shaft in horsepower				Power output from generator driven as indicated - in kilowatts				
	Current wheel	Over-shot wheel, wooden buckets	Over-shot wheel, metal buckets	Turbine	Current wheel through jack shaft	Wooden overshot through jack shaft	Metal overshot through jack shaft	Turbine direct drive	Turbine through gear or shaft
1	0.030				0.0085				
2	0.061				0.0200				
3	0.100	0.118	0.133	0.18	0.036	0.050	0.062	0.118	0.105
4	0.133	0.18	0.200	0.29	0.061	0.087	0.095	0.167	0.154
5	<u>0.18</u>	0.25	0.29	0.38	<u>0.083</u>	0.118	0.132	0.21	0.200
6		0.32	0.36	0.48		0.154	0.172	0.26	0.24
7		0.40	0.43	0.56		0.189	0.21	0.32	0.29
8		0.48	0.54	0.65		0.22	0.26	0.37	0.33
9		0.57	0.67	0.76		0.26	0.31	0.43	0.40
10		0.68	0.76	0.85		0.31	0.37	0.50	0.45
11		0.78	0.87	0.94		0.37	0.42	0.54	0.50
12		0.88	0.98	1.05	Impulse wheel	0.43	0.48	0.60	0.55
13	Impulse (Pelton) wheel	0.98	1.11	1.14	direct drive	0.48	0.52	0.65	0.60
14		1.05	1.20	1.22		0.51	0.57	0.70	0.64
15		1.14	1.28	1.33		0.56	0.62	0.76	0.70
16	1.18	1.23	1.41	1.41	0.68	0.60	0.68	0.81	0.75
18	1.33	1.43	1.61	1.59	0.76	0.68	0.78	0.90	0.83
20	1.52	1.59	1.79	1.72	0.83	0.76	0.88	0.98	0.90
22	1.69	1.72	2.00	1.89	0.99	0.84	0.97	1.08	0.99
24	1.92	1.89	2.2	2.0	1.10	0.91	1.05	1.15	1.05
25	2.0	2.0	2.3	2.1	1.16	0.95	1.10	1.19	1.08
30	2.4	<u>2.3</u>	<u>2.7</u>	2.4	1.39	<u>1.15</u>	<u>1.31</u>	1.41	1.27
35	2.9			2.8	1.67			1.64	1.47
40	3.2			3.2	1.89			1.85	1.69
45	3.8			3.7	2.2			2.1	1.89
50	4.2			4.0	2.4			2.3	2.1
75	6.4			<u>5.9</u>	3.7			<u>3.4</u>	<u>3.1</u>
100	8.5				5.0				
125	10.5				6.2				
150	12.5				7.2				
200	16.7				9.6				
300	24.4				14.3				
400	32.2				18.9				
500	40.0				23.8				

Data for this table were compiled from water flow tables for numerous commercial wheels, and from design and experimental data on homemade wheels. They should not be expected to fit any given installation exactly, but should give a good indication of what may be expected from commercial wheels or from well constructed homemade wheels.

TABLE 2.--EFFICIENCIES OF WATER POWER PLANTS

Type of wheel	Efficiency of wheel	Overall efficiency of wheel, power drive, and generator
Homemade current wheel	10% to 40%	7% to 30%
Homemade overshot wheel	20% to 70%	15% to 50%
Commercial current wheel	20% to 50%	10% to 35%
Commercial overshot wheel	50% to 80%	30% to 60%
Commercial turbine	60% to 85%	
Direct drive		45% to 70%
Gear or belt drive		38% to 65%
Commercial impulse wheel	60% to 80%	45% to 70%

TABLE 3.--EQUIVALENT HEADS FOR GIVEN VELOCITIES*

Velocity ft./sec.	Equivalent head in feet				
	0.0	0.2	0.4	0.5	0.8
0	0.0000	0.0006	0.0025	0.0056	0.0099
1	0.0155	0.0224	0.0305	0.0398	0.0503
2	0.0622	0.0752	0.0895	0.1050	0.1218
3	0.1398	0.1591	0.1796	0.2013	0.2243
4	0.2486	0.2741	0.3008	0.3267	0.3580
5	0.3885	0.4201	0.4631	0.4872	0.5227
6	0.5594	0.5973	0.6364	0.6768	0.7185
7	0.7614	0.8055	0.8508	0.8975	0.9453
8	0.9945	1.0448	1.0964	1.1492	1.2033
9	1.2586	1.3151	1.3729	1.4320	1.4923
10	1.5539	1.6166	1.6806	1.7459	1.8124
11	1.8802	1.9492	2.0194	2.0909	2.1636
12	2.2376	2.3126	2.3892	2.4669	2.5458

*These values do not take into account friction or other losses.

APPENDIX III.

ENERGY AND POWER LOSSES

Whenever water is put to work, and the energy which is released is converted from one form into another, some of the total available energy will be lost. Some of these losses are unavoidable, but all must be kept as small as possible, for otherwise they may dissipate a major part of the water energy which is available. The more important sources of energy loss, which will be found in most water power plants, are:

1. Loss of head in delivering water to the wheel.
2. Loss of water through leakage of canals, flumes, or leakage within the wheel.
3. Loss of head in removing water from the vicinity of the wheel.
4. Loss due to impact with and friction in passing through or over the buckets, runners, or blades.
5. Loss due to turbulence or splashing caused by disturbing the stream flow in passing through the wheel or turbine.
6. Mechanical losses due to friction in the bearings, wind resistance, etc.

Some carefully built water wheels and turbines have been able to keep the total of these losses as low as 10 per cent of the available energy. In other words, "efficiencies" as high as 90 per cent or more have been attained, but such cases are unusual. Ordinarily the best efficiencies obtainable on direct drives from the wheels or turbines will be between 75 per cent and 85 per cent, while 50 per cent to 60 per cent will be more common where homemade equipment is used.

APPENDIX IV.

SIZES OF ELECTRICAL CONDUCTORS

TABLE 4.—ALLOWABLE LENGTHS OF TRANSMISSION LINE

Plant voltage and allowable drop	Kilowatt capacity	Allowable length of line in feet											
		Wire sizes											
		12	10	8	6	4	3	2	1	0	00	000	
8 v. (2-v. drop)	0.25		24	36	60	95	120	150	200	250	300	400	
	0.50			19	30	46	60	75	100	125	150	200	
	0.75				20	32	40	50	65	80	100	130	
	1.00					24	30	38	50	60	75	100	
35-38 v. (4-v. drop)	0.5	80*	125	200	320	510	650	800	1000	1300	1650	2000	
	1.0	40	65	100	160	250	325	400	510	650	820	1000	
	1.5	25	40	70	100	170	215	270	350	430	550	700	
	2.0		30	50	80	125	160	200	250	325	410	510	
	3.0			35	55	85	100	135	170	215	275	335	
120-125 v. 2 wire system (5-v. drop)	0.5	350*	575	900	1450	2300	2900	3700	4650	5900	7300	8650	
	1.0	180*	290	450	730	1150	1450	1850	2300	2900	3700	4650	
	1.5	120*	190	300	385	770	975	1200	1550	1950	2500	3100	
	2.0	90*	145	230	360	530	730	920	1150	1450	1850	2300	
	3.0	60*	95	150	240	380	495	610	775	975	1230	1550	
	4.0	34	72	115	180	285	365	460	580	730	925	1150	
	5.0	36	57	92	145	230	290	370	465	585	740	930	
240-250 v. 3 wire system (10 volt drop)	1.0	725*	1150	1050	2000	4600							
	2.0	360*	575	920	1450	2300	2900	3700	4650	5900	7300	8650	
	3.0	240*	390	610	970	1550	1950	2500	3100	3900	4900	6000	
	4.0	180*	290	450	725	1150	1450	1850	2300	2900	3700	4650	
	5.0	145*	230	365	550	925	1150	1470	1850	2350	2950	3700	
	7.5	97*	155	240	385	620	780	980	1250	1550	1950	2500	
	10.0	72*	115	185	290	460	580	735	930	1150	1500	1850	
	12.5	58*	92	147	230	370	465	590	745	935	1200	1500	
	15.0	48	75	120	190	310	385	490	615	780	980	1250	

*Spans of more than 50 feet without intermediate support should not use smaller than No. 10 wire.

TABLE 5.--MINIMUM WIRE SIZES FOR ELECTRIC CIRCUITS

Approximate voltage at plant	Minimum size of wire to use for:						
	*Entrance to house	*Entrance to out-buildings	Branch circuits	Small motors 1 hp. or less	Motors 1 hp. to 3 hp.	Motors 3 hp. to 5 hp.	Electric range circuit
8 v. D.C.	4	6	8	6 ^a	---	---	---
35-38 v. D.C.	6	8	10	10 to 6 ^b	---	---	---
120-125 v. D.C. or A.C.	6 ^c	8	12 ^d	14	8	6	---
125 and 250 v. D.C. or A.C.	3-6 ^e	8	12 ^d	14	12 ^f	8 ^f	3-6 ^g

*Entrance should in no case be smaller than the largest circuit in the building.

^aMotors larger than 1/4 hp. are not practical on this voltage.

^b1/4 hp. - No. 10; 1/2 hp. - No. 10; 3/4 hp. - No. 8; 1 hp. - No. 6.

^cPlants of less than 1.5 kw. capacity can use No. 8 entrance.

^dNo. 14 is allowed for short branches to lighting loads. No. 12 should be used on all appliance branch circuits.

^eThree No. 6 conductors. Where plant has capacity of 5 kw. or more, three No. 4 or larger wire should be used.

^fThese motors operate on 230-240 volts.

^gTwo No. 6 and one No. 8 are sometimes used.